



HAL
open science

Transient Regime to Support Steady State Directional Function in Presence of Strong Capacitive Currents in Compensated MV Systems

Wan-Ying Huang, Robert Kaczmarek

► **To cite this version:**

Wan-Ying Huang, Robert Kaczmarek. Transient Regime to Support Steady State Directional Function in Presence of Strong Capacitive Currents in Compensated MV Systems. IPST 2007, 2007, Lyon, France. pp.1-4. hal-00242496

HAL Id: hal-00242496

<https://hal-centralesupelec.archives-ouvertes.fr/hal-00242496>

Submitted on 6 Feb 2008

HAL is a multi-disciplinary open access archive for the deposit and dissemination of scientific research documents, whether they are published or not. The documents may come from teaching and research institutions in France or abroad, or from public or private research centers.

L'archive ouverte pluridisciplinaire **HAL**, est destinée au dépôt et à la diffusion de documents scientifiques de niveau recherche, publiés ou non, émanant des établissements d'enseignement et de recherche français ou étrangers, des laboratoires publics ou privés.

Transient Regime to Support Steady State Directional Function in Presence of Strong Capacitive Currents in Compensated MV Systems

W.-Y.Huang, R.Kaczmarek

Abstract—An SLG fault detection task can be out of reach of steady state methods, based on detection of active component in faulty currents. Efficiency of these methods may not be assured when strong capacitive currents on faulty feeder squeeze the phase shift between the faulty and the sound zero sequence currents below actual acquisition limits.

Then the way to assure the directional decision is to exploit data recorded in transient regime, where an apparent phase difference is more important than actual phase difference in steady state. This is a consequence of the way the transient regime develops, beginning just after the fault inception with phase opposition between the faulty and the sound current residuals and finishing in steady state with a slight phase advance of the faulty residual over all the sound ones.

Keywords: fault detection, distribution systems, compensated systems

I. INTRODUCTION

SELECTIVE ground fault detection methods in distribution systems use the in-phase component of the zero-sequence current to discriminate the faulty feeder. The method known for a long time [1]-[2] has until recently been still developed under variant application options, either by comparing signs of projections of zero sequence currents [3]-[4] or looking for phase advance [5]-[6] of the faulty zero sequence current over the sound ones.

It has proved efficient in overhead line systems, confirming general consensus on these methods, which are abundantly cited in literature, but never critically discussed. However, with cable proliferation in distribution systems its re-evaluation seems relevant because strong capacitive currents diminish the phase advance between residuals, with possible inhibition of the discrimination capacities of relays.

We will see this phenomenon in steady state SLG fault

regime in a radial compensated network (**Fig. 1**). It can be analyzed on equivalent residual circuit (**Fig. 2**), where V'' is the voltage over a SLG fault emplacement in absence of this fault [7], $I_{0,f}$ - zero sequence current on faulty feeder, $\Sigma I_{0,s}$ - the sum of zero sequence currents on all the sound feeders and I_N is the neutral point current composed of a resistive and an inductive currents.

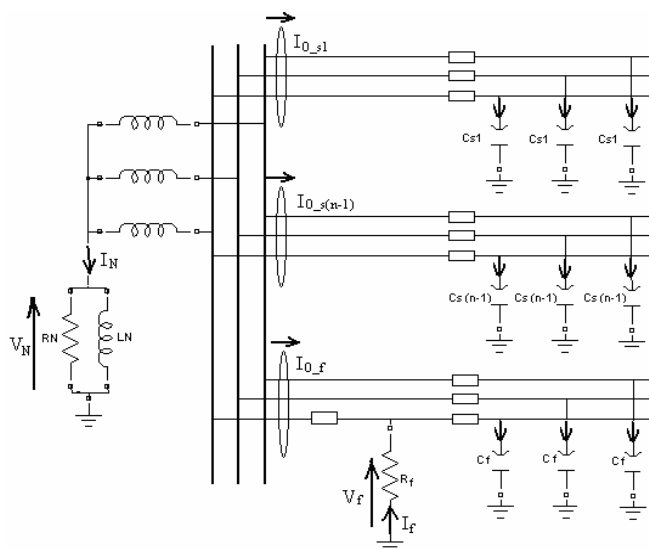

Fig. 1. A radial distribution network with an SLG fault.

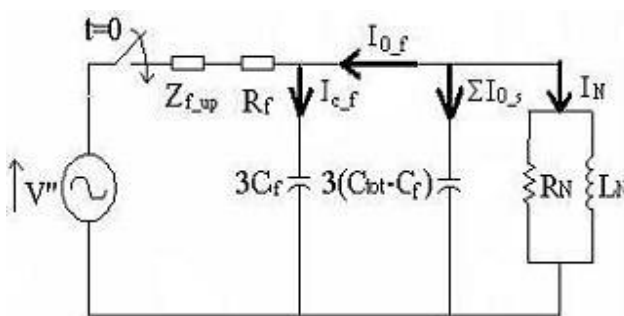

Fig. 2. An equivalent residual circuit of the distribution system from Fig. 1, with the up-stream line impedance $Z_{f,up}$ from busbar to fault

This work was supported in part by Tsing Hua University in Taiwan and by Schneider Electric France
W.-Y. Huang is with Supelec, 91192 Gif sur Yvette, France (e-mail: wanying.huang@supelec.fr)
R. Kaczmarek is with Supelec, Gif sur Yvette, France (e-mail: robert.kaczmarek@supelec.fr)

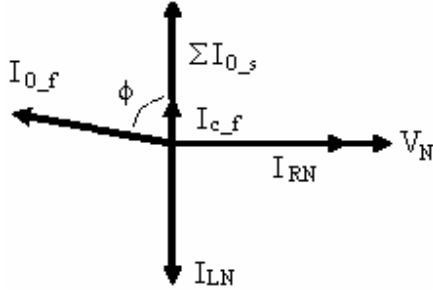

Fig. 3. The faulty feeder diagnosis depends on readability of the phase advance ϕ of I_{0_f} over I_{0_s} .

During the fault regime, an active current component is present in zero sequence current I_{0_f} on the faulty feeder. The resulting phase difference between the faulty and the sound zero sequence currents I_{0_s} (Fig. 3) is the basis of the wattmetric methods of detection.

II. PHASE ADVANCE READABILITY

Efficiency of wattmetric methods can be evaluated by the limits of phase difference between residuals for various types of distribution systems with a permanent SLG fault. We take 600Hz as frequency of acquisition to get the phase difference. Its minimal detectable value is then $\phi = 30^\circ$.

In low capacitive lines the phase advance can be almost 90° , because under effect of compensation we have (Fig. 2):

$$I_{0_f} = -I_N - \sum I_{0_s} = I_{c_f} - I_{RN} \quad (1)$$

where the faulty residual I_{0_f} is dominated by its active component I_{RN} .

In cables however the faulty feeder capacitive current I_{c_f} dominates the composition of I_{0_f} and diminishes the readability of the phase advance, particularly with fault on a long feeder or in case of system over tuning.

The same limitation is to be reckoned with in case of another variant of the method, with projections of zero sequence currents as basis for directional function. The relevant static algorithm is efficient if the faulty phase zero sequence capacity is less than one third of the total system zero sequence capacity [8].

A. Homogenous radial system

From the equivalent circuit (Fig. 2) we have

$$tg \phi = 3R_N C_f \omega \quad (2)$$

We consider a 10kV 3*3.3MVA compensated system with I_{RN} limited to 5A, which we get with $R_N = 1155\Omega$. The overhead lines to carry this supply present the zero sequence capacity of $C=0.0047\mu F/km$ and the corresponding underground cables (Fig. 4) - $C=0.364\mu F/km$.

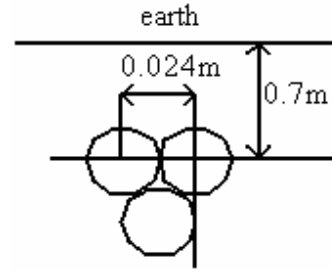

Fig. 4. Underground cable disposition in study case

In such conditions the minimal value of 30° for the phase advance is reached with 340km line and 4.5km cable. For lines the length limits are actually not critical, but when fault occurs even on a feeder with even relatively short cable line, the 600Hz frequency may be not enough to detect the phase difference and to discriminate the feeders.

B. Mixed radial system

This consideration can be of special interest in mixed, cable and line feeders, with faults occurring on the overhead, non-isolated part. Obviously, unless the latter is very long comparing to cable length, the phase difference between zero sequence currents will be determined by the cable. No significant influence should be here expected from fault resistance or fault location as stated in (Tab. 1) with EMTP simulation results for 5km cable + 30km overhead line for each of three feeders in mixed 10kV 3*3.3MVA system.

TABLE I
PHASE DIFFERENCE ϕ BETWEEN SOUND AND FAULTY ZERO SEQUENCE CURRENTS IN MIXED CABLE+OVERHEAD LINE SYSTEM

Fault location	Fault resistance	ϕ in degrees
in the middle of line	1000 Ω	25
in the middle of line	1 Ω	24
in the middle of cable	1000 Ω	28
in the middle of cable	1 Ω	25

With 5km cable we have here the phase difference always less than the critical value of 30° .

C. Cable radial system with laterals

The above discussion on directional function can be relevant in cables only in case of final stage isolation degradation, which can rapidly develop toward a low restive permanent fault [9]. Obviously, an extraordinary complexity of fault nature in cables – like space charge evolution under strong field, or electrical tree following a water tree or mechanical or thermal stress - does not allow a simple modeling without contest [10]. We accept a fault of isolation to be modeled as a switching-in of a resistance as soon as precursory phenomena prepare conditions for breakdown and the breakdown occurs.

Then we can try a study case of a ramified system (Fig. 5) with low fault resistance (1 Ω) and phase difference measured on busbar abc.

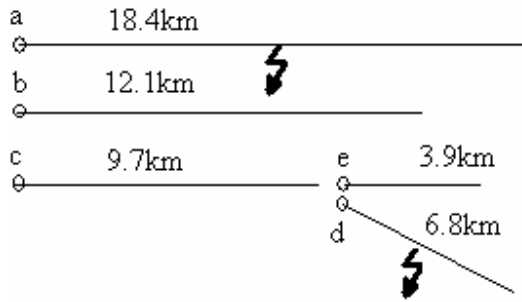

Fig. 5. Feeders disposition for study case

With fault on feeder “d” the zero sequence currents on all sound feeders (“a”, “b” and “e”) are almost in-phase and the phase difference ϕ_{ac} between currents on “a” and “c” is 7° , indicating the fault on one of the “c” feeder’s group, but this phase is certainly too low to be detected with 600Hz acquisition.

With sensors on all feeders’ departure we get more pronounced indication $\phi_{ad} = 20^\circ$, but this is still to low comparing to 30° limit.

When the fault occurs on “a” then residuals on “b”, “c”, “d”, and “e” are in-phase, whereas the faulty feeder is pointed by phase difference $\phi_{ab}=7^\circ$.

D. Mixed radial system with laterals

To get the mixed system we replace cables on feeders “e” and “d” (of Fig. 5) by 30km overhead lines and place the fault on “d”. With in-phase residuals on “a”, “b” and “e”, the directional information in steady state is given by phase difference $\phi_{ac}=14^\circ$ measured on busbar, or by $\phi_{ad}=20^\circ$ measured at ramification point.

Although the static wattmetric methods apply in principle also in case of ramified systems, the frequency of acquisition may be a problem when cable length is above certain well correlated value, here 4.5km.

In cases where the critical cable length is of conditional concern, for example with only one feeder approaching this length, there is no use in changing the installed relays, but their efficiency will be confirmed if some auxiliary procedures are available.

As far as static methods are concerned there can be two ways of dealing the limits of low frequency acquisition: either to raise the active current component I_{RN} or to look after an apparent phase difference in transient regime.

III. AN APPARENT PHASE ADVANCE IN TRANSIENT REGIME

As a matter of fact, an analogous parameter in transient regime can be much larger.

This is a consequence of the way the transient regime develops, beginning with phase opposition between faulty and sound current residuals [11] and finishing in steady state with the well known phase advance of the faulty residual over all the sound ones.

This development is correlated with evolution of the neutral point current I_N smoothly growing from zero to its permanent value. During the first millisecond after fault inception it can grow very slowly, particularly with resistive faults, because of high values of the neutral point elements L_N and R_N .

On the contrary, the feeders’ line-to-ground capacitors C_f and C_s charge and discharge vigorously. During a short time interval after fault inception the neutral point current I_N is negligible comparing to capacitive zero sequence currents.

The latter being under the same charging conditions, the faulty zero sequence current is initially in phase opposition to the sound feeders zero sequence currents, see (2):

$$I_{0_f} = -(\sum I_{0_s}) \quad (2)$$

and proceeds toward zero level with different polarities (Fig. 6). The capacitive zero sequence currents having transients with time constants very short before the fundamental periods they take rapidly form of sinusoids leading the zero sequence voltage V_0 by 90° . Consequently, all the sound residuals cross the zero level in the same moment, whereas the faulty one follows development of its zero sequence component I_0 .

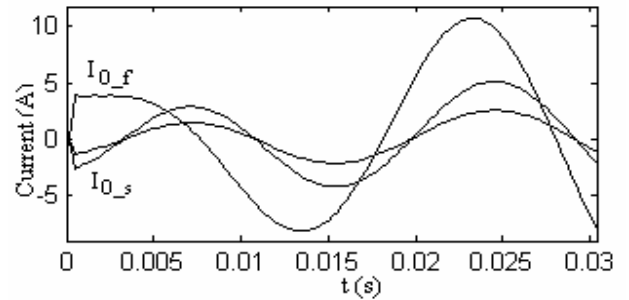

Fig. 6 Faulty and sound current residuals in radial three feeders system of Fig. 1. ($R_f=1k\Omega$, $\theta=90^\circ$)

This is evident also in systems with laterals (Fig. 7), like the one of Fig. 5 with cable feeders “d” and “e” prolonged with 30km of overhead lines. The fault location on the feeder “d” is pointed by residuals “c” and “d” which cross the zero level elsewhere than all the other residuals.

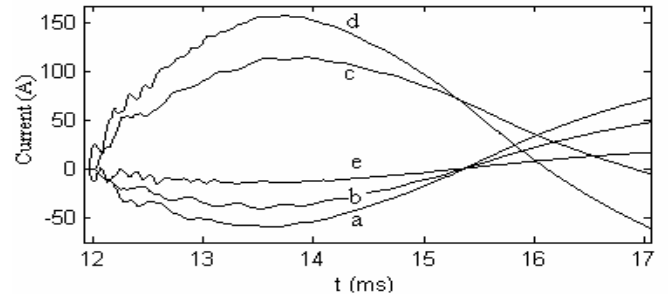

Fig. 7 Faulty (“c” and “d”) and sound current residuals in radial five feeders system of Fig. 5, with 30km overhead lines prolonging cables on feeders “d” and “e”, an SLG fault on “d”. $R_f=1k\Omega$, $\theta=90^\circ$

Replacing cables by lines on feeders “d” and “e” leads to more pronounced oscillations without changing phenomena (Fig. 8)

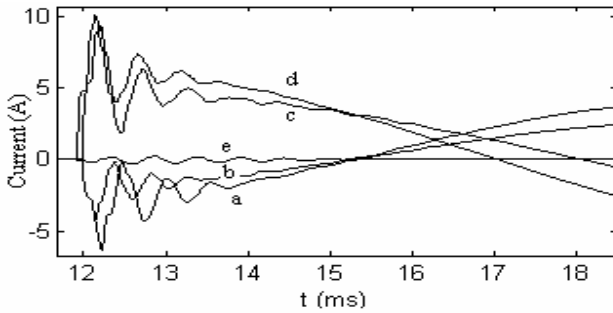

Fig. 8 Faulty (“c” and “d”) and sound current residuals in radial five feeders system of Fig. 5, with 30km overhead lines replacing cables on feeders “d” and “e”, an SLG fault on “d”. $R_f=1k\Omega$, $\theta=90^\circ$

The identification of faulty feeder operates then with aid of following algorithm.

Algorithm

We detect the slopes of filtered residuals at their first zero crossing after the fault inception. The analysis depends on network type. Basic algorithm [12] concerns radial systems:

If all but one witness the same slope sign in the same time instant, then we can declare the latter as the faulty one without even controlling its zero crossing:

$$\text{IF } I_k(t_0) = 0 \text{ for } k = 1 \dots n-1$$

$$\text{AND } \text{sgn}\left(\frac{dI_1}{dt}\right) = \text{sgn}\left(\frac{dI_2}{dt}\right) = \dots = \text{sgn}\left(\frac{dI_{n-1}}{dt}\right) \text{ at } t = t_0 \quad (3)$$

THEN the n^{th} feeder is the faulty one.

This is a one shoot procedure, without possibility of verification. On the other hand it is a conclusive test, as the matter goes about unambiguous identification of slopes’ signs.

IV. CONCLUSION

The faulty zero sequence current is initially in phase opposition to the sound feeders zero sequence currents and proceeds toward zero level with different polarities. Examination of these polarities assumes the directional function no matter what is the weight of capacitive currents in the monitored system. It is a robust procedure but it can be applied only once in the transient zone, so it can serve as a subsidiary way to the well known steady-state methods whenever their efficiency may not be assured because of low frequency of acquisition of zero sequence currents.

V. REFERENCES

[1] AIEE Committee Report, “Sensitive Ground Protection”, AIEE Trans., vol. 69, 1950, pp. 473-476
 [2] E.T.B.Gross, “Sensitive Fault Protection for Transmission Lines and Distribution Feeders”, AIEE Trans., vol. 60, nov. 1941, pp. 969-972

[3] D. Griffel, Y. Harmand, V. Leitloff and J. Bergeal, “A new deal for safety and quality on MV networks”, *IEEE Trans. Power Delivery*, vol. 12, n°4, pp. 1428-1433, Oct. 1997
 [4] T. Welfonder, V. Leitloff, R. Feuillet and S. Vitet, “Location strategies and evaluation of detection algorithms for earth faults in compensated MV distribution systems”, *IEEE Trans. Power Delivery*, vol. 15, n°4, pp. 1121-1128, Oct. 2000
 [5] P. Bastard, P. Bertrand, T. Emura, M. Meunier, “The Technique of Finite-Impulse-Response Filtering Applied to Digital Protection and Control of Medium Voltage Power System”, *IEEE Trans. Power Delivery*, vol. 7, n°2, pp. 620-626, April 1992
 [6] T. Segui, P. Bertrand, M. Guillot, P. Hanchin and P. Bastard, “Fundamental Basis for Distance Relaying with Parametrical Estimation”, *IEEE Trans. Power Delivery*, vol. 16, n° 1, pp. 99-104, Jan. 2001
 [7] W.-Y. Huang, R. Kaczmarek, “Symmetric Components for Transient Regime Application in MV Systems”, IPST07, Lyon 2007
 [8] V. Letloff, “Etude, Conception et Realisation d’un Automate de Gestion de Réseaux MT compensés”, Ph.D. dissertation, LEG Grenoble, 1994
 [9] V. Leitloff, private contribution
 [10] Revue de l’Electricité et de l’électronique, Power Cables and Insulating Materials Science, August 1996
 [11] W.-Y. Huang, R. Kaczmarek, “Wave Propagation Regime to Point to the Faulty Feeder in Mixed Cable-and-Lines Distribution Systems with an SLG Fault”, IPST07, Lyon 2007
 [12] W.-Y.Huang, “Identification rapide des paramètres d’un défaut monophasé dans un réseau compensé de distribution sans mesure de tension”, Ph.D. Dissertation, Dept. Energie, Supelec and Université Paris XI, 2006.

VI. BIOGRAPHIES



Wan-Ying HUANG has graduated from Tsing Hua University in Taiwan with Master Degree in 2002 and in 2006 has got her PHD in the Ecole Supérieure d’Electricité SUPELEC and University Paris XI in France. She is now on a post doctoral research program in SUPELEC, working on protections in distribution systems and optimal design of electric machines.

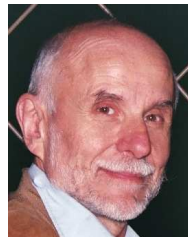

Robert KACZMAREK is professor in the Ecole Supérieure d’Electricité (Supelec) in France. His research interest is with power networks (fault detection, network protection, and parameters identification), magnetism (domain observation, loss prediction and measurements in soft and hard magnetic materials) and the design of electric machines.