



HAL
open science

Spectral Efficiency of Spectrum Pooling Systems

Majed Haddad, Aawatif Hayar, Merouane Debbah

► **To cite this version:**

Majed Haddad, Aawatif Hayar, Merouane Debbah. Spectral Efficiency of Spectrum Pooling Systems. IEEE Transactions on Communications, 2008, 2 (6), pp. 733-741. hal-00326351

HAL Id: hal-00326351

<https://hal-centralesupelec.archives-ouvertes.fr/hal-00326351>

Submitted on 2 Oct 2008

HAL is a multi-disciplinary open access archive for the deposit and dissemination of scientific research documents, whether they are published or not. The documents may come from teaching and research institutions in France or abroad, or from public or private research centers.

L'archive ouverte pluridisciplinaire **HAL**, est destinée au dépôt et à la diffusion de documents scientifiques de niveau recherche, publiés ou non, émanant des établissements d'enseignement et de recherche français ou étrangers, des laboratoires publics ou privés.

Spectral Efficiency of Spectrum Pooling Systems

Majed Haddad and Aawatif Hayar

Mobile Communications Group, Institut Eurecom,

2229 Route des Cretes, B.P. 193,

06904 Sophia Antipolis, France

Email: majed.haddad@eurecom.fr, aawatif.hayar@eurecom.fr

Mérouane Debbah

SUPELEC, Plateau de Moulon, 3 rue Joliot-Curie

91192 Gif sur Yvette Cedex, France

Email: merouane.debbah@supelec.fr

Abstract

In this contribution, we investigate the idea of using *cognitive radio* to reuse locally unused spectrum to increase the total system capacity. We consider a multiband/wideband system in which the primary and cognitive users wish to communicate to different receivers, subject to mutual interference and assume that each user knows only his channel and the unused spectrum through adequate sensing. The basic idea under the proposed scheme is based on the notion of *spectrum pooling*. The idea is quite simple: a cognitive radio will listen to the channel and, if sensed idle, will transmit during the voids. It turns out that, although its simplicity, the proposed scheme showed very interesting features with respect to the spectral efficiency and the maximum number of possible pairwise cognitive communications. We impose the constraint that users successively transmit over available bands through selfish water filling. For the first time, our study has quantified the asymptotic (with respect to the band) achievable gain of using spectrum pooling in terms of spectral efficiency compared to classical radio systems. We then derive the total spectral efficiency as well as the maximum number of possible pairwise communications of such a spectrum pooling system.

Index Terms

Cognitive radio, spectrum pooling, sensing, power detection, capacity, spectral efficiency, band factor gain, water filling.

I. INTRODUCTION

The recent boom in personal wireless technologies has led to an increasing demand in terms of spectrum resources. To combat this overcrowding, the FCC has recently recommended [2] that significantly greater spectral efficiency could be realized by de-ploying wireless devices that can coexist with the licensed (primary) users, generating minimal interference while taking advantage of the available resources. The current approach for spectrum sharing is regulated so that wireless systems are assigned fixed spectrum allocations, operating frequencies and bandwidths, with constraints on power emission that limits their range. Therefore, most communication systems are designed in order to achieve the best possible spectrum efficiency within the assigned bandwidth using sophisticated modulation, coding, multiple antennas and other techniques.

On the other hand, the discrepancy between spectrum allocation and spectrum use suggests that this spectrum shortage could be overcome by allowing more flexible usage of a spectrum. Flexibility would mean that radios could find and adapt to any immediate local spectrum availability. A new class of radios that is able to reliably sense the spectral environment over a wide bandwidth, detect the presence/absence of legacy users (primary users) and use the spectrum only if the communication does not interfere with primary users is defined by the term *cognitive radio* [3]. Cognitive radios (CR) have been proposed as a mean to implement efficient reuse of the licensed spectrum. The key feature of cognitive radios is their ability to recognize their communication environment and *independently* adapt the parameters of their communication scheme to maximize the quality of service (QoS) for the secondary (unlicensed) users while minimizing the interference to the primary users.

The basic idea within the paper is based on *spectrum pooling*. The notion of spectrum pooling was first mentioned in [4]. It basically represents the idea of merging spectral ranges from different spectrum owners (military, trunked radio, etc.) into a common pool. It also reflects the need for a completely new way of spectrum allocation as proposed in [5]. The goal of spectrum pooling is to enhance spectral efficiency by overlaying a new mobile radio system on an existing one without requiring any changes to the actual licensed system.

Another technique that has been increasingly popular is Time Division Duplexing (TDD) in which the same carrier is used for both links in different time slots. One property of such systems is that, since the same frequency is used, the channel characteristics are nearly the same in both links, provided the channel does not change too rapidly.

Motivated by the desire for an effective and practical scheme, our study treats the problem of spectrum pooling from sensing to achievable performance. We consider an asynchronous TDD communication scenario in which the primary and cognitive users wish to communicate to different receivers, subject to mutual interference in a heterogeneous network where devices operate in a wideband/multiband context. However, contrary to the work addressed in [6], in this contribution, we impose as a first step that only one user can simultaneously transmit over the same sub-band using successive water filling. Especially OFDM based WLANs like IEEE802.11a and HIPERLAN/2 are suitable for an overlay system like spectrum pooling as they allow a very flexible frequency management on a carrier-by-carrier basis. We examine the total spectral efficiency of the spectrum pooling system and show that the overall system spectral efficiency can be considerably enhanced by considering cognitive communications with respect to the traditional system (without cognition). In particular, it is of major interest, in this context, to quantify the spectral efficiency gain in order to show the interest behind using spectrum pooling terminals with respect to classical systems (without cognition). In fact, although spectrum pooling has spurred great interest and excitement, many of the fundamental theoretical questions on the limits of such technologies remain unanswered. The merits of our approach lie in the simplicity of the proposed scheme and, at the same time, its efficiency. Results showed very interesting performance in terms of the number of cognitive users allowed to transmit as well as the system spectral efficiency gain we get. Such an accurate and simple system modeling presents a key to understand the actual benefits brought by spectrum pooling technology.

The rest of the paper is organized as follows: In Section II, we describe the channel model. In Section III, we describe the spectrum pooling protocol. In Section IV, we address the problem of sensing. Section V details the spectral efficiency analysis adopted throughout this paper when the number of sub-bands is limited. In Section VI, we investigate the asymptotic performance of such a system in terms of spectral efficiency. Performance evaluation is provided in Section VII and Section VIII concludes the paper.

II. THE CHANNEL MODEL

The baseband discrete-frequency model at the receiver \mathfrak{R}_l (see Figure 1) is:

$$y_{\mathfrak{R}_l}^i = h_l^i \sqrt{P_l^i(h_l^i)} S_l^i + n_l^i, \quad \text{for } i = 1, \dots, N \quad \text{and} \quad l = 1, \dots, L \quad (1)$$

where:

- h_l^i : is the block fading process of user l on the sub-band i ,
- S_l^i : is the symbol transmitted by user l on the sub-band i ,
- $P_l^i(h_l^i)$: is the power control¹ of user l on the sub-band i ,
- n_l^i : is the additive Gaussian noise at the i th sub-band.

We further assume that the channel h_l stays constant over each block fading length (i.e. coherent communication). The assumption of coherent reception is reasonable if the fading is slow in the sense that the receiver is able to track the channel variations. We statistically model the channel gains h_l to be i.i.d distributed over the L Rayleigh fading coefficients and $\mathbb{E} \left\{ |h_l|^2 \right\} = 1$ for $l = 1, \dots, L$. The additive Gaussian noise n_l at the receiver is i.i.d circularly symmetric and $n_l \sim \mathcal{CN}(0, N_0)$ for $l = 1, \dots, L$.

III. THE SPECTRUM POOLING PROTOCOL

We consider an asynchronous TDD communication scenario in which the primary and cognitive users wish to communicate to different receivers, subject to mutual interference. The basic idea under the proposed protocol is quite simple: the cognitive users listen to the wireless channel and determine, either in time or frequency, which part of the spectrum is unused. Then, they *successively* adapt their signal to fill detected voids in the spectrum domain. Each transmitter \mathcal{T}_l for $l = 1, \dots, L$ estimates the pilot sequence of the receiver \mathfrak{R}_l in order to determine the channel gain h_l (see links (1) and (3) in Fig. 1). Notice here that since we are in a TDD mode, when we estimate the channel in one way, we can also know it the other way. Thus, each user l is assumed to know only his own channel gain h_l and the statistical properties of the other links (probability distribution). We further assume that the channel does not change from the instant of estimation to the instant of transmission.

A particularly noteworthy target in this context, when we employ a "listen-before-talk" strategy, is to reliably detect the sub-bands that are currently accessed by a specified user in order to be spared from

¹Throughout the rest of the paper, we will find it convenient to denote by P_l^i the power allocation policy of user l on sub-band i , rather than $P_l^i(h_l^i)$.

the coming users transmission. This knowledge can be obtained from two manners: In a centralized mode where the proposed system would require information from a third party (i.e. central database maintained by regulator or another authorized entity) to schedule users coming. Alternatively, an extra signalling channel is dedicated to perform the collision detection so that cognitive users will not transmit at the same moment. Specifically, the primary user comes first in the system and estimates his channel gain. The second user comes in the system randomly, for instance in a Poisson process manner, and estimates his channel link. Such an assumption could be further justified by the fact that in an asynchronous context, the probability that two users decide to transmit at the same moment is negligible as the number of users is limited. Thus, within this setting, the primary user is assumed not to be aware of the cognitive users. He communicates with his receiver in an ad-hoc manner while a set of spectrum pooling transmitters that are able to reliably sense the spectral environment over a wide bandwidth, decide to communicate with their respective receivers only if the communication does not interfere with the primary user. Accordingly, under our opportunistic approach, a device transmits over a certain sub-band only when no other user does. Such an assumption is motivated by the fact that when \mathfrak{X}_l sends his pilot sequence to \mathcal{T}_l , he will not interfere with \mathcal{T}_{l-1} for $l = 2, \dots, L$. The sensing operation will be discussed in the next section. Throughout the rest of the paper, we will adopt this framework to analyze the achievable performance of such a system in terms of spectral efficiency as well as the maximum number of possible pairwise communication within this scenario. Such an accurate and simple system modeling presents a key to understand the actual benefits brought by spectrum pooling technology. In fact, although cognitive radios have spurred great interest and excitement in industry, many of the fundamental theoretical questions on the limits of such technologies remain unanswered.

Moreover, in order to characterize the achievable performance limit of such systems, three capacity measures can be found in the literature. A comprehensive review of these concepts can be found in [7]. The relevant performance metric of the proposed protocol is the instantaneous capacity per sub-band in bits/s/Hz, also called *spectral efficiency*, namely [8]:

$$C_l = \frac{1}{N} \sum_{i=1}^N \log_2 \left(1 + \frac{P_l^i |h_l^i|^2}{N_0} \right); \quad l = 1, \dots, L \quad (2)$$

The sum here is done over the stationary instantaneous distribution of the fading channel on each user l . The instantaneous capacity determines the maximum achievable rate over all fading states without a delay constraint. In this work, we allocate transmit powers for each user (over a total power budget constraint)

in order to maximize his transmission rate. In fact, when channel state information is made available at the transmitters, users know their own channel gains and thus they will adapt their transmission strategy relative to this knowledge. The corresponding optimum power allocation is the well-known *water filling* allocation [9] expressed by²:

$$P_l^i = \left(\frac{1}{\gamma_0} - \frac{N_0}{|h_l^i|^2} \right)^+ \quad (3)$$

where γ_0 is the Lagrange's multiplier satisfying the average power constraint per sub-band:

$$\frac{1}{N} \sum_{i=1}^N P_l^i = \bar{P} \quad (4)$$

Without loss of generality, throughout the rest of the paper, we take $\bar{P} = 1$.

Notice that, although a water filling power allocation strategy is adopted in this analysis, we emphasize that this is not a restriction of the proposed protocol. In fact, as mentioned before, one important task when implementing spectrum pooling is that cognitive users operate on the idle sub-bands of the licensed system delivering a binary channel assignment as shown in Fig. 2. Hence, our study is valid for any binary power control without resorting to the restriction assumption of successive water filling.

For clarity sake, let us take the following example with $N = 8$ sub-bands. As shown in Figure 2, the primary user is always prioritized above cognitive users by enjoying the entire band while cognitive users adapt their signal to fill detected voids with respect to their order of priority. As a first step, the primary user maximizes his rate according to his channel process. As mentioned before in expression (3), only user with a channel gain h^i above a certain threshold equal to $\gamma_0 \cdot N_0$ transmits on the sub-band i (Ψ_2). User 2, comes in the system randomly, senses the spectrum and decides to transmit only on sub-bands sensed idle. Thus, following his fading gains, user 2 adapts his signal to fill these voids in the spectrum domain in a complementary fashion (Ψ_3). Similarly, user 3 will sense the remaining sub-bands from user 1 and user 2 and decides to transmit during the remaining voids (Ψ_4).

IV. SENSING ISSUE

So far, we have focused on pairwise communications between transmitters and receivers (see links 1 and 3 in Fig. 1). Let us now investigate the *inter-transmitter* communications (link 2 in Fig. 1) in order

² $(x)^+ = \max(0, x)$.

to analyze the problem of sensing. To this effect, let us assume the baseband discrete-time model within a coherence time period T when each user l for $l = 2, \dots, L$ has N sub-bands as described in Figure 1:

$$y_l^i(k) = c_{l-1,l}^i(k) \sqrt{P_{l-1}^i (h_{l-1}^i)^2} S_{l-1}^i(k) + n_{l-1}^i(k), \quad (5)$$

where $c_{l-1,l}^i(k)$ is the block fading process from user $l-1$ to user l on the i th sub-band, at time k . We further assume that $0 \leq k \ll \beta T$ and $\beta < 1$, i.e. the coherence time is sufficiently large so that the channel stays constant for samples and jumps to a new independent value (block-fading model).

The proposed sensing techniques hinge on the assumption that all devices operate under a unique standard so that they know the pilot sequence used by the other users.

As stated above, in this work, the spectrum pooling behavior is assumed to allow only one user to simultaneously transmit over the same sub-band. The received signal at user l can therefore be written as (see link 2 in Fig. 1):

$$y_l^i(k) = \begin{cases} \underbrace{c_{l-1,l}^i(k) \sqrt{P_{l-1}^i} S_{l-1}^i(k)}_{\text{signal}} + \underbrace{n_{l-1}^i(k)}_{\text{noise}}, & \text{if } P_{l-1}^i \neq 0 \\ n_{l-1}^i(k), & \text{otherwise} \end{cases} \quad (6)$$

By assuming that βT is an integer equal to M and by making βT sufficiently large, the mean received power over the detection duration at receiver \mathfrak{R}_l is:

$$\lim_{M \rightarrow \infty} \frac{1}{M} \sum_{k=1}^M |y_l^i(k)|^2 = \begin{cases} |c_{l-1,l}^i|^2 P_{l-1}^i + N_0, & \text{if } P_{l-1}^i \neq 0 \\ N_0, & \text{otherwise} \end{cases} \quad (7)$$

Accordingly, in order to determine which part of the spectrum is unused, cognitive user has just to detect the received power and compare it to the noise power N_0 . However, in addition to the fact that it supposes that $M \rightarrow \infty$ (i.e. infinite time coherence period), the proposed method would be not efficient at low SNR-regime (see Figure 3). In fact, the quality of such a technique is strongly degraded with the reduction in the precision of the noise threshold [10][11]. The principal difficulty of this detection is to obtain a good estimation of the noise variance. In the setting of spectrum pooling mechanism, we would need a channel

sensing method that continuously senses the channel. Thus, the channel sensing should be performed with a very high probability of correct detection (to assure very low probability of interference with the primary system). Weiss *et al.* proposed in [12] a distributed spectrum pooling protocol where all the nodes participate in channel sensing so that all cognitive users perform detection. Moreover, formulas for the calculation of the detection and false alarm probability in a spectrum pooling system have been derived in [13] for the general case of an arbitrary primary systems covariance matrix.

V. SPECTRAL EFFICIENCY ANALYSIS

Let us first define the set of the number of sub-bands sensed occupied by user l by:

$$\Psi_l = \{i \in \{1, \dots, N\}; P_{l-1}^i \neq 0\} \quad (8)$$

where Ψ_l obeys to the following properties:

$$\left\{ \begin{array}{l} \Psi_1 = \emptyset, \\ \bigcup_{l=1}^{L+1} \Psi_l \subseteq \{1, \dots, N\}, \\ \bigcap_{l=1}^{L+1} \Psi_l = \emptyset \end{array} \right. \quad (9)$$

The spectral efficiency per sub-band of user l , given a number of sub-bands N , is:

$$C_{l,N} = \frac{1}{\text{card}(\Omega_l)} \sum_{i \in \Omega_l} \log_2 \left(1 + \frac{P_l^i |h_l^i|^2}{N_0} \right) \quad \text{bits/s/Hz} \quad (10)$$

where Ω_l represents the set of the remaining idle sub-bands sensed by user l , namely:

$$\Omega_l = \left\{ i \in \{1, \dots, N\} \cap \overline{\bigcup_{k=1 \dots l} \Psi_k} \right\} \quad (11)$$

For a given number of sub-bands N , the optimal power allocation which maximizes the transmission rate of user l is the solution to the following optimization problem:

$$\max_{P_l^1, \dots, P_l^{\text{card}(\Omega_l)}} C_{l,N}, \quad \text{for } l = 1, \dots, L$$

subject to the average power constraint per sub-band:

$$\begin{cases} \frac{1}{\text{card}(\Omega_l)} \sum_{i \in \Omega_l} P_l^i = 1, \\ P_l^i \geq 0, \end{cases} \quad (12)$$

The resulting optimal power control policy is given by (3). Notice that the maximum number of users L allowed by such a system must satisfy the condition that $\text{card}(\Omega_L) \neq 0$.

Let us now derive the spectral efficiency of such a system. The spectral efficiency per band of user l is given by:

$$\Phi_{l,N} = \frac{1}{N} \cdot \sum_{i \in \Omega_l} \log_2 \left(1 + \frac{P_l^i |h_l^i|^2}{N_0} \right) \quad (13)$$

By multiplying and dividing (13) by $\text{card}(\Omega_l)$, we obtain³:

$$\Phi_{l,N} = \frac{\text{card}(\Omega_l)}{N} \cdot C_{l,N}, \quad \text{for } l = 1, \dots, L \quad (14)$$

As expected, when $l = 1$, the spectral efficiency without cognition is equal to the primary user spectral efficiency $C_{1,N}$. We define $\Delta_{l,N}$ as the band factor gain of user l for N sub-bands, namely:

$$\Delta_{l,N} \triangleq \frac{\text{card}(\Omega_l)}{N}, \quad \text{for } l = 1, \dots, L \quad (15)$$

In other words, the band factor gain represents the fraction of the band unoccupied at user l . The spectral efficiency per band of user l can therefore be expressed by:

$$\Phi_{l,N} = \Delta_{l,N} \cdot C_{l,N}, \quad \text{for } l = 1, \dots, L \quad (16)$$

and the sum spectral efficiency of a system with N sub-bands per user is given by:

$$\Phi_{\text{sum},N} = \sum_{l=1}^L \Phi_{l,N} \quad (17)$$

³Notice that since the primary user enjoys the entire bandwidth, we have: $\text{card}(\Omega_1) = N$.

VI. ASYMPTOTIC PERFORMANCE

Let us now study the achievable performance when devices operate in a wide-band context (i.e. $N \rightarrow \infty$). The spectral efficiency of user l for a large number of sub-bands in (10) becomes:

$$C_{l,\infty} = \int_0^\infty \log_2 \left(1 + \frac{P_l(t) \cdot t}{N_0} \right) \cdot f(t) dt, \quad \text{for } l = 1, \dots, L \quad (18)$$

where P_l is subject to the average constraint:

$$\int_0^\infty P_l(t) \cdot f(t) dt = 1 \quad (19)$$

Although this is not a restriction of our approach, from now on we assume that the channel gains are i.i.d Rayleigh distributed. However, all theoretical results as well as the methodology adopted in this paper can be translated immediately into results for any other probability distribution function of the channel model. In this way, the term $f(t)$ in (18) will be replaced by the appropriate probability distribution function. The spectral efficiency of user l for i.i.d Rayleigh fading is given by:

$$C_{l,\infty} = \int_0^\infty \log_2 \left(1 + \frac{P_l(t) \cdot t}{N_0} \right) \cdot e^{-t} dt, \quad \text{for } l = 1, \dots, L \quad (20)$$

where P_l is subject to the average constraint:

$$\int_0^\infty P_l(t) \cdot e^{-t} dt = 1 \quad (21)$$

and γ_0 is the Lagrange's multiplier satisfying⁴:

$$\frac{1}{\gamma_0} \int_{\gamma_0 \cdot N_0}^{+\infty} e^{-t} dt - N_0 \cdot E_i(\gamma_0 \cdot N_0) = 1 \quad (22)$$

Numerical root finding is needed to determine different values of γ_0 . Our numerical results, in section VII, show that γ_0 increases as N_0 decreases, and γ_0 always lies in the interval $[0,1]$. On the other hand, an asymptotic expansion of (22) in [14] shows that at very high SNR-regime, $\gamma_0 \rightarrow 1$.

⁴ $E_i(x)$ is the exponential integral function defined as: $E_i(x) = \int_x^{+\infty} \frac{e^{-t}}{t} dt$.

Moreover, the spectral efficiency of user l can be computed for $l = 1, \dots, L$ as follows:

$$\begin{aligned}
C_{l,\infty} &= \int_0^\infty \log_2 \left(1 + \frac{P_l(t) \cdot t}{N_0} \right) \cdot e^{-t} dt \\
&= \int_{\gamma_0 N_0}^\infty \log_2 \left(1 + \frac{\left(\frac{1}{\gamma_0} - \frac{N_0}{t} \right) \cdot t}{N_0} \right) \cdot e^{-t} dt \\
&= \int_{\gamma_0 N_0}^\infty \log_2 \left(\frac{t}{\gamma_0 \cdot N_0} \right) \cdot e^{-t} dt \\
&= \frac{1}{\ln(2)} \cdot E_i(\gamma_0 \cdot N_0)
\end{aligned} \tag{23}$$

In order to characterize the achievable performance of such system in terms of spectral efficiency, we define the spectral efficiency within the frequency bandwidth W , as [15]:

$$C_{l,\infty}(W) = \frac{1}{W} \int_{-\frac{W}{2}}^{\frac{W}{2}} \log_2 \left(1 + \frac{P_l(f) \cdot |H_l(f)|^2}{N_0} \right) df \tag{24}$$

By identifying expression (20) with (24), we obtain a characterization of the frequency variation f as function of the channel gains t , namely:

$$f = -W \cdot e^{-t} + \frac{W}{2}, \tag{25}$$

Similar to our approach in the previous section, we define the band factor gain Δ_∞ as the fraction of the band sensed idle from user l to user $l+1$ over the total bandwidth W for an infinite number of sub-bands:

$$\Delta_\infty \triangleq \frac{\Delta f}{W} \tag{26}$$

where Δf represents the frequency interval where the fading gain in (25) is below a certain threshold equal to $\gamma_0 \cdot N_0$. By deriving the appropriate vacant band Δf when $t \in [0, \gamma_0 \cdot N_0]$ in (25), we obtain:

$$\Delta_\infty = 1 - \exp(-\gamma_0 \cdot N_0) \tag{27}$$

Accordingly, the asymptotic spectral efficiency of user l is given by:

$$\Phi_{l,\infty} = \Delta_\infty \cdot C_{l,\infty}, \quad \text{for } l = 1, \dots, L \tag{28}$$

Similar to the case where the number of sub-bands is fixed, when $l = 1$, the spectral efficiency without cognition is equal to the primary user spectral efficiency $C_{1,\infty}$. In particular, it is of major interest to quantify the spectral efficiency gain Δ_∞ in order to show the interest behind using spectrum pooling terminals with respect to classical systems (without cognition). To do so, following the same procedure and going from user 2 to L , we obtain the expression of the asymptotic spectral efficiency as function of $C_{1,\infty}$:

$$\Phi_{l,\infty} = \Delta_\infty^{l-1} \cdot C_{1,\infty}, \quad \text{for } l = 1, \dots, L \quad (29)$$

The overall asymptotic sum spectral efficiency for a system with L users is therefore:

$$\begin{aligned} \Phi_{sum,\infty} &= \sum_{l=1}^L \Phi_{l,\infty} \\ &= \sum_{k=0}^{L-1} \Delta_\infty^k C_{1,\infty} \\ &= \underbrace{\frac{1 - \Delta_\infty^L}{1 - \Delta_\infty}}_{\geq 1} \cdot C_{1,\infty} \end{aligned} \quad (30)$$

Thus, the sum spectral efficiency obtained by considering cognitive communications is greater than or equal to the spectral efficiency without cognition $C_{1,\infty}$. Such a result, rather intuitive, justifies the increasing interest behind using cognitive radio terminals in future wireless communication systems since the sum spectral efficiency of such systems performs always better than classical communication systems (without cognition).

On the other hand, by substituting $C_{1,\infty}$ by its expression in (23), we obtain the final expression of the achievable sum spectral efficiency in such a system:

$$\Phi_{sum,\infty} = \frac{1}{\ln(2)} \cdot \frac{1 - \Delta_\infty^L}{1 - \Delta_\infty} \cdot E_i(\gamma_0 \cdot N_0) \quad (31)$$

This result is very interesting as, by only knowing the statistics of the channel gains (through γ_0) and the SNR (through N_0), one can derive the achievable spectral efficiency as well as the potential gain resulting from using spectrum pooling.

VII. PERFORMANCE EVALUATION

In order to validate our approach in the previous Section, we compare the theoretical expression of the sum spectral efficiency in (31) to expression in (17). We model L i.i.d Rayleigh channels (one for each user) and assume perfect sensing of the idle-sub-bands. Our numerical result in Figure 4, tends to validate the asymptotic analysis we adopt throughout the paper. It clearly shows that the sum spectral efficiency in (17) matches expression (31) even for a moderate number of sub-bands N (from $N = 16$).

Moreover, since the maximum number of users is not theoretically limited, we will consider only L that satisfies the condition that $\text{card}(\Omega_L) \neq 0$, otherwise, the L -th spectral efficiency would be negligible. Figure 5 characterizes the maximum number of users L as function of the received signal energy per information bit E_b/N_0 for different number of sub-bands N . As expected, we remark that the maximum number of users allowed to transmit increases with the number of sub-bands especially at low E_b/N_0 region. Furthermore, the maximum number of cognitive users ranges from 1 to 8. As an example, the proposed scheme, although its simplicity allows up to 4 cognitive users to benefit from the licensed spectrum at 8 dB for $N = 2048$ sub-bands.

In [1], we analyzed the different configurations of the sum spectral efficiency for a system with 5 users as function of the SNR. We showed that at low SNR region, the spectral efficiency is significantly increased with respect to the traditional system without cognition while, at high SNR regime, the maximum sum spectral efficiency reaches $C_{1,\infty}$. In this paper however, we will focus on the sum spectral efficiency gains as function of E_b/N_0 . In fact, the E_b/N_0 versus spectral efficiency characteristic is of primary importance in the study of the behavior of the required power in the wideband limit (where the spectral efficiency is small). The key idea behind doing so is to find the best tradeoff between transmitted energy per information bit and spectral efficiency [15]. It is also useful for the sake of comparing results obtained for different configurations to represent the fundamental limits in terms of received energy per information bit rather than the Signal-to-noise ratio. By replacing the SNR in (23) by its equivalent expression in terms of E_b/N_0 , the spectral efficiency of the primary user becomes:

$$C_{1,\infty} = \frac{1}{\ln(2)} \cdot E_i \left(\frac{\gamma_0}{\frac{E_b}{N_0} \cdot C_{1,\infty}} \right) \quad (32)$$

In such a case, the explicit solution of the spectral efficiency versus E_b/N_0 is not feasible. In Figure 6, we plot the sum spectral efficiency gains (with respect to the configuration where only the primary user enjoys

the entire band) as function of E_b/N_0 where solutions are given by the implicit equation in (32). The goal here is rather to quantify the spectrum pooling spectral efficiency gain from user to user. Simulation results were obtained through dichotomic algorithms in Figure 6. We found out that the maximum spectral efficiency gain can not exceed the range of 60% for a configuration with one primary user and 4 cognitive users. Notice that, as E_b/N_0 increases, all the configurations tend towards the configuration where only the primary user enjoys the entire band. This can be justified by the fact that, at high E_b/N_0 regime, the water-level $\frac{1}{\gamma_0}$ is becoming greater than the quantity $\frac{N_0}{|h|^2}$ and more power is poured within each sub-band (see equation(3)).

To proceed further with the analysis, we resort to performance comparison of the proposed scheme with respect to a traditional system where no cognition is used. As far as sum spectral efficiency comparison is concerned, this can be conducted by considering the two following configurations:

- *the non-cognitive radio configuration (NCR)*: where the primary user enjoys the entire bandwidth following an average power constraint per sub-band given by:

$$\frac{1}{N} \sum_{i=1}^N P_i^j = L \cdot \bar{P} \quad (33)$$

where L is the maximum number of users at each SNR (as shown in Fig. 5). The primary user can accordingly distribute $(N \cdot L \cdot \bar{P})$ over the N sub-bands in order to maximize his capacity,

- *the cognitive configuration*: where $(L-1)$ cognitive users coexist with the primary user while sharing the N sub-bands available. Each user has to maximize his capacity with respect to the average power constraint per band of $(\text{card}(\Omega_l) \cdot \bar{P})$ as in (12).

Figure 7 validates the expectation from the analysis in (30). It clearly shows that the spectrum pooling strategy performs always better than traditional communication system using the same spectral resources due to the multi-user diversity gain. In particular, the spectrum pooling system achieves 1 bit per second per hertz more than the NCR system.

Let us now focus on the band factor gains expressions. So far, we have quantified the spectral efficiency gains of different configurations with five users. Let us now investigate how the simulated spectral efficiency gain (with a finite N) converges to the theoretical one (when N is assumed to be infinite).

Let us first write the spectral efficiency of each user l as follows:

$$\Phi_{l,\infty} = \alpha_{l,\infty} \cdot C_{1,\infty}, \quad \text{for } l = 1, \dots, L \quad (34)$$

where:

$$\alpha_{l,\infty} = \Delta_{\infty}^{l-1}, \quad \text{for } l = 1, \dots, L \quad (35)$$

Note here that $\alpha_{l,\infty}$ represents the band factor gain from the primary user to user l . In Figure 8, numerical simulation is carried out by considering a system with four cognitive users. We compared simulated values of $\alpha_{l,N}$ based on equation (14) to theoretical values in (35) for each user l and for SNR = 10 dB. We remark that as N increases, the simulated band factor gain tends to $\alpha_{l,\infty}$. Moreover, simulation results show that $\alpha_{2,N}$ converges more rapidly to the associated theoretical gain factor value than for user 3 or user 4.

VIII. CONCLUSION

In this work, we have considered a new strategy called Spectrum Pooling enabling public access to the new spectral ranges without sacrificing the transmission quality of the actual license owners. For the first time, our analysis has quantified the achievable gain of using spectrum pooling with respect to classical radio devices. We found out that though its simplicity, the proposed scheme is effective to provide a higher spectral efficiency gain than the classical scheme does. We further obtained a characterization of the achievable spectral efficiency as well as the maximum number of possible pairwise communications within such a scenario. Simulation results validate our theoretical claims and offer insights into how much one can gain from spectrum pooling in terms of spectral efficiency. As a future work, it is of major interest to generalize the problem to limited feedback in order to characterize the sum spectral efficiency gain of such cognitive protocols with respect to the proposed scenario. It would be further interesting to measure the throughput of the proposed protocol given a realistic primary system model (e.g., ethernet traffic) compared to an OFDM/TDD overlay cognitive radio system.

REFERENCES

- [1] M. Haddad, M. Debbah and A.M. Hayar, "Spectral Efficiency for Cognitive Radio Systems", *in proceeding of IEEE Global Telecommunications Conference (GLOBECOM 2007)*, Washington, D.C, USA, 2007.
- [2] Federal Communications Commission, Cognitive Radio Technologies Proceeding (CRTP), <http://www.fcc.gov/oet/cognitiveradio/>.
- [3] J. Mitola, "*Cognitive radio: An integrated agent architecture for software defined radio*", Doctor of Technology, Royal Inst. Technol. (KTH), Stockholm, Sweden, 2000.
- [4] J. Mitola, "Cognitive Radio for Flexible Mobile Multimedia Communications", *Mobile Multimedia Communications (MoMUC 1999)*, New York, November, 1999.
- [5] T. Weiss and F. Jondral, "Spectrum pooling: An innovative strategy for the enhancement of spectrum efficiency", *IEEE Communications Magazine*, vol.42, no.3, March 2004.
- [6] M. Haddad, M. Debbah and A.M. Hayar, "Distributed Power Allocation for Cognitive Radio", *in proceeding of IEEE ISSPA*, February 2007, Sharjah, United Arab Emirates.
- [7] E. Biglieri, J. Proakis, and S. Shamai, "Fading channels: Information- theoretic and communications aspects", *IEEE Trans. Inf. Theory*, vol. 44, no. 6, pp. 2619 - 2692, Oct. 1998.
- [8] D. Tse and P. Viswanath, "*Fundamentals of Wireless Communication*," Cambridge University Press, 2005.
- [9] T. M. Cover and J. A. Thomas, *Elements of Information Theory*", Wiley, 1991.
- [10] K. V. Cai, V. Phan and R. J. O'Connor, "Energy Detector Performance in a Noise Fluctuating Channel", *IEEE Military Communications Conference*, vol. 1, pp. 85 - 89, Oct. 1989.
- [11] H. L. Van Trees, "*Detection, estimation, and modulation theory: Radar-Sonar Signal Processing and Gaussian Signals in Noise-Part III*", Wiley, 2nd ed., 2001.
- [12] T. Weiss, J. Hillenbrand, A. Krohn and F. Jondral, "Efficient Signaling of Spectral Resources in Spectrum Pooling Systems", *Proc. of the SCVT Eindhoven*, Netherlands, 2003.
- [13] J. Hillenbrand, T. Weiss, and F. Jondral, "Calculation of detection and false alarm probabilities in spectrum pooling systems", *IEEE Electronic Letters*, April 2005.
- [14] I. Gradshteyn and I. Ryzhik, *Tables of Integrals, Series, and Products*, New York: Academic, 1980.
- [15] S. Verdu, "Spectral Efficiency in the Wideband Regime", *IEEE Trans. Information Theory, Special Issue on Shannon Theory: Perspective, Trends and Applications*, vol. 48, pp. 1319–1343, June 2002.

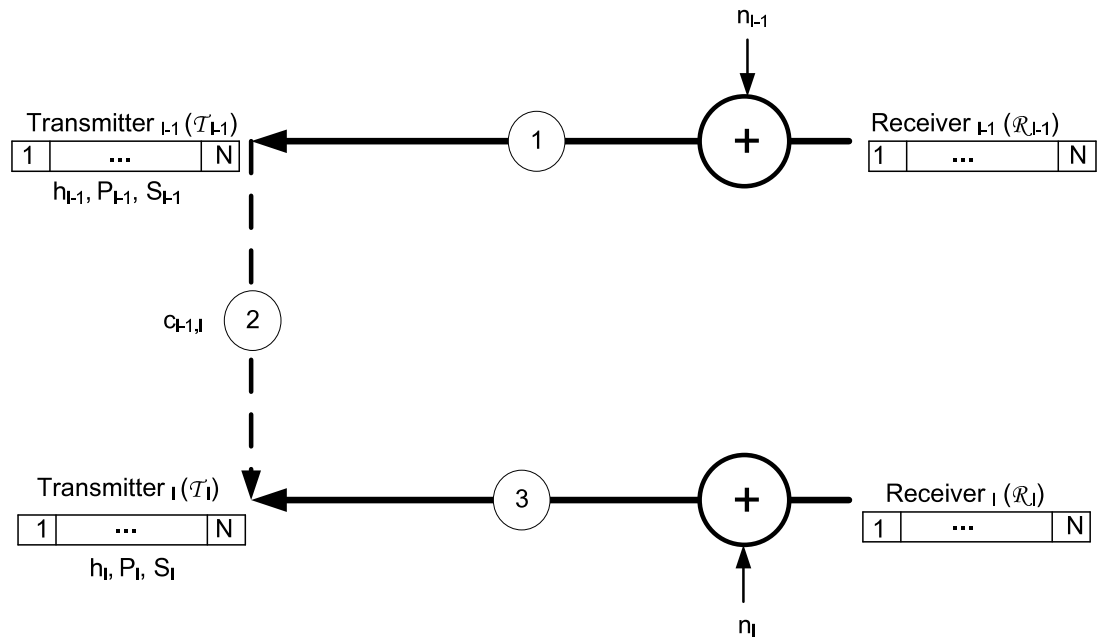

Fig. 1. The cognitive radio channel in a wideband/multiband context with N sub-bands.

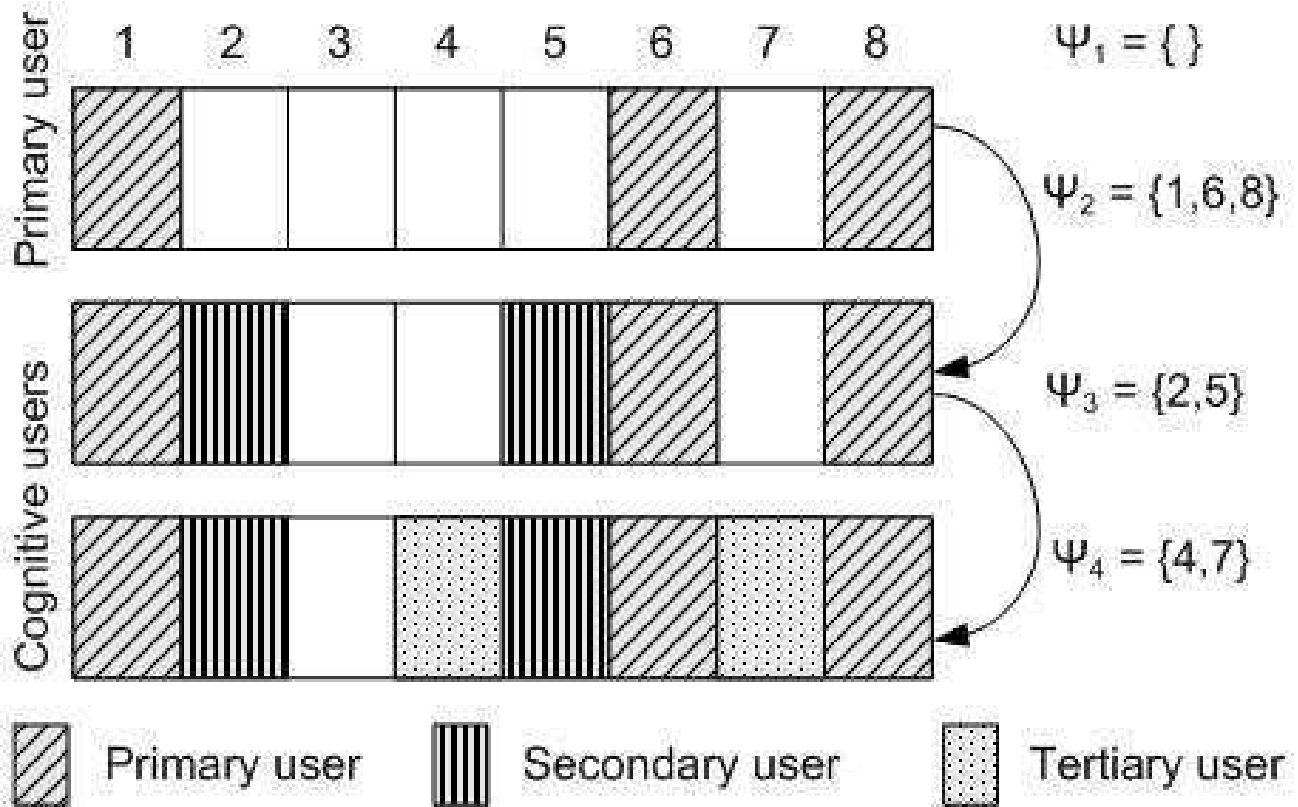

Fig. 2. One primary user and two cognitive users in a spectrum pooling system with 8 sub-bands.

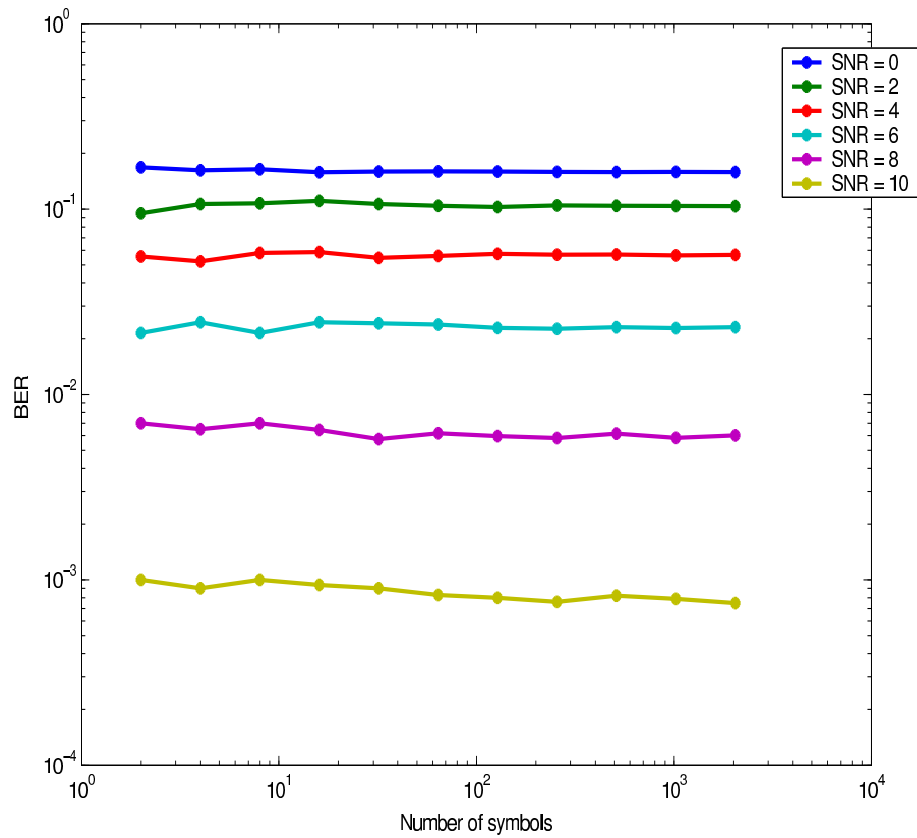

Fig. 3. BER v.s number of symbols (M) in dB for BPSK in AWGN using power detection where SNR are in dB.

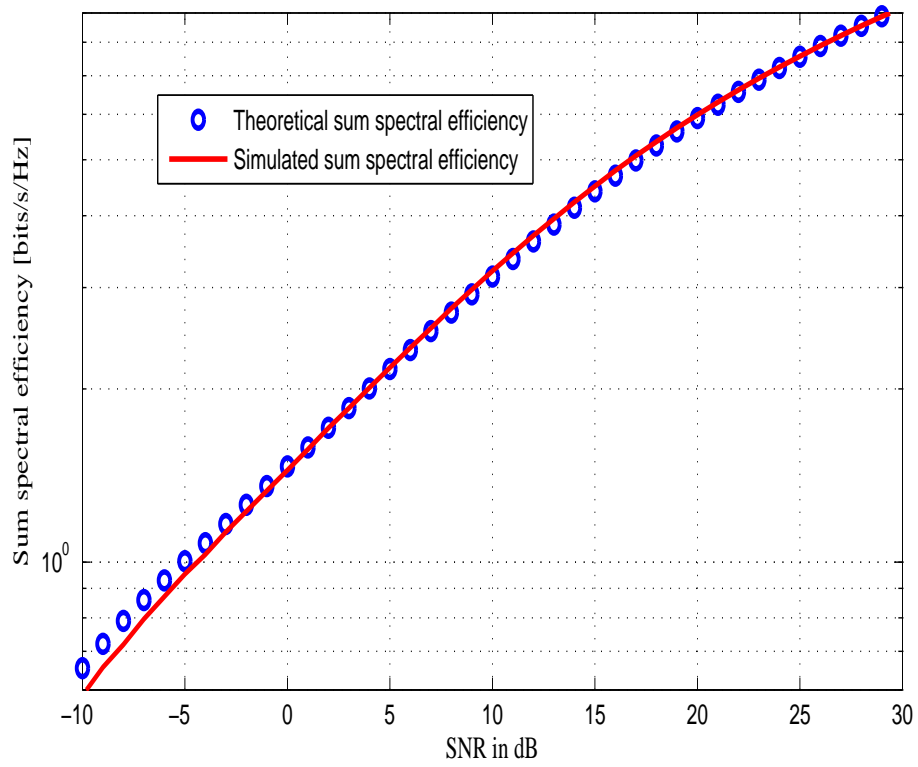

Fig. 4. Comparison between theoretical expression of the sum spectral efficiency in (31) and simulated one in (17) for $L = 5$ and $N=16$.

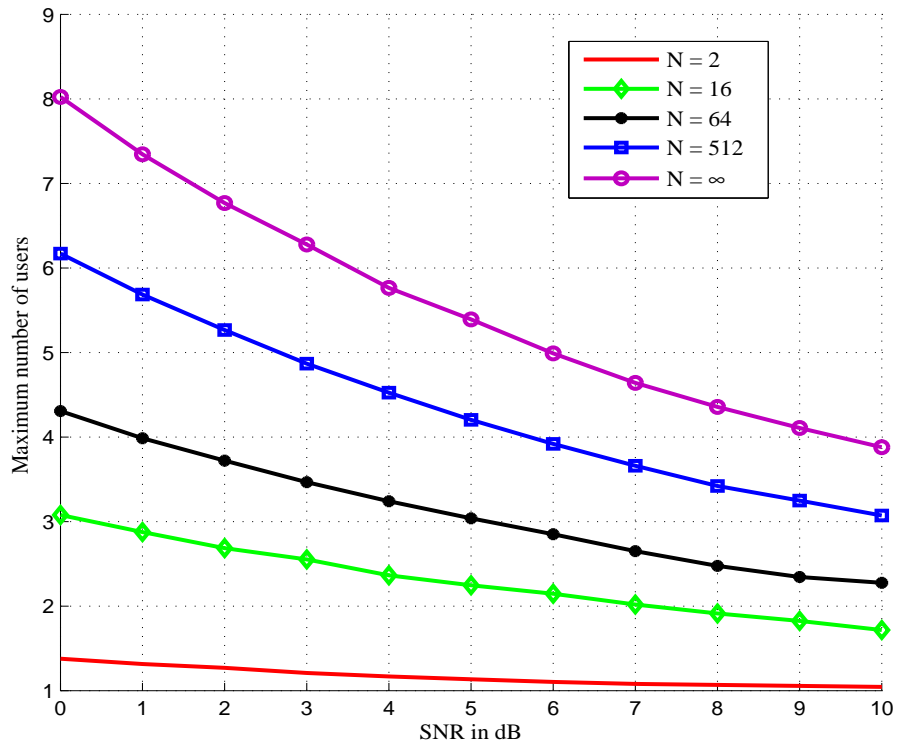

Fig. 5. The maximum number of users for different number of sub-bands (N).

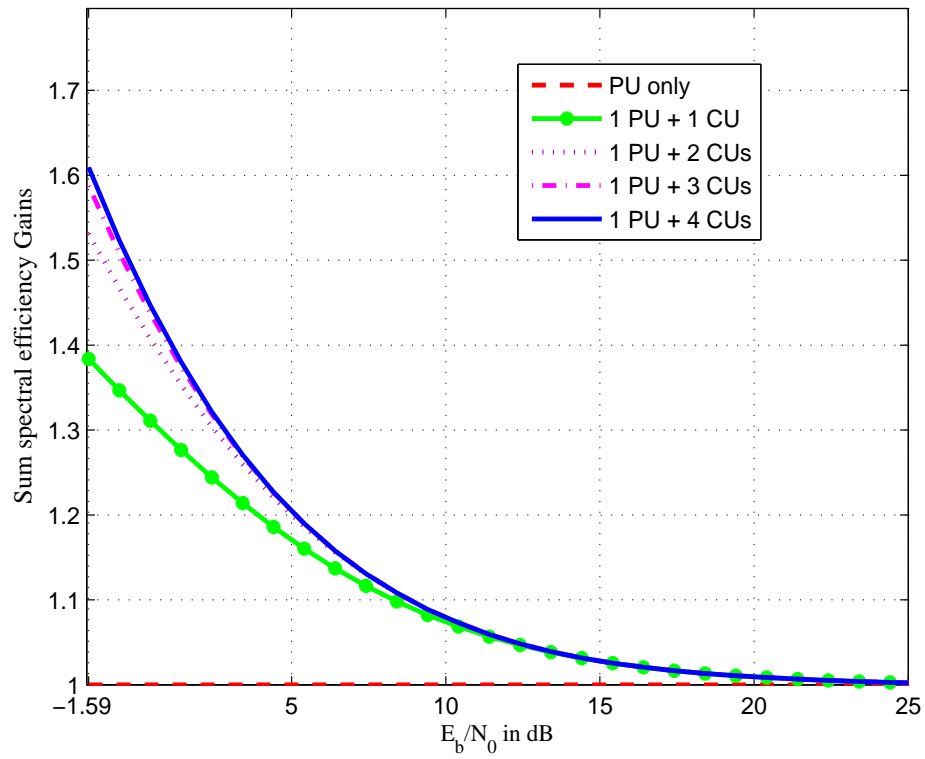

Fig. 6. Sum spectral efficiency gains of the system with one primary user and 4 cognitive users (CU).

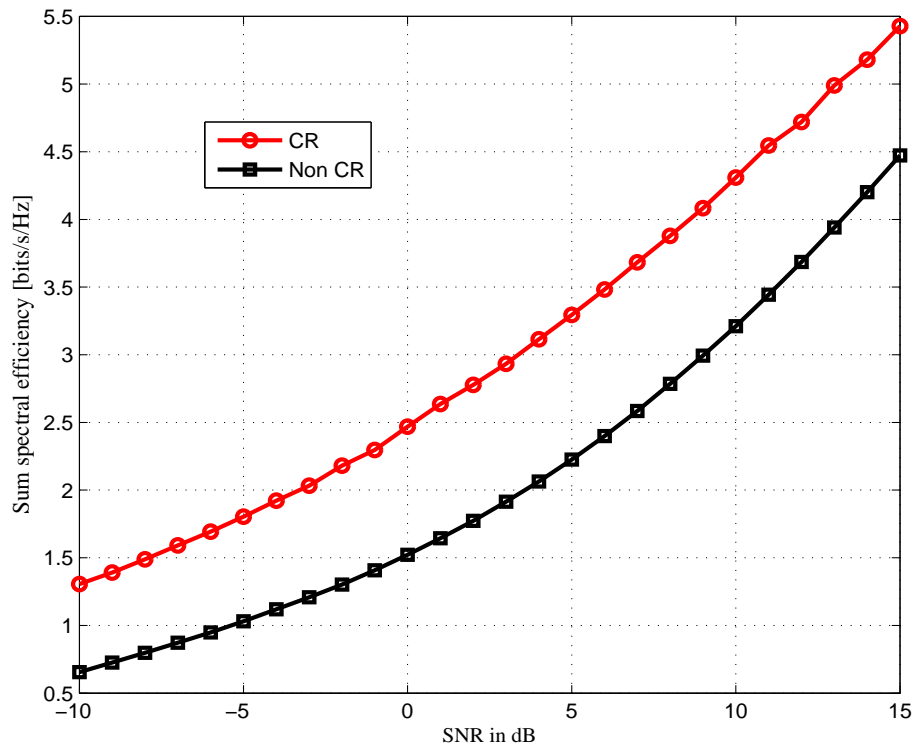

Fig. 7. Sum spectral efficiency of a system using cognitive radio (CR) and a traditional system (Non CR) for $N = 512$.

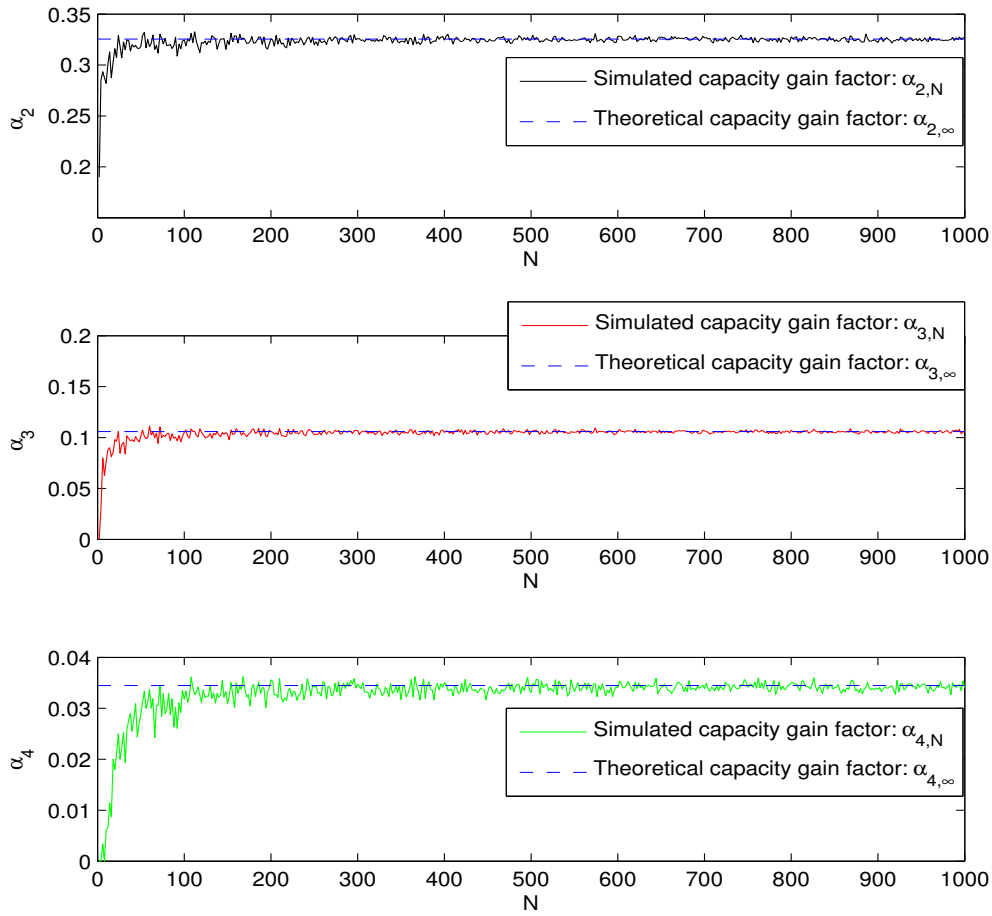

Fig. 8. Convergence of band factor gains at SNR = 0 dB.