



HAL
open science

Fostering Energy Efficiency in manufacturing plants through economical breakthroughs in power and flow rate measurement

Anne Le Mouel, Gilbert Schmitt, Maxime Dupont, Charles Joubert, Menad Bourkeb, Olivier Ondel, Caroline Courtier, Lionel Duvillaret, Yann Gaeremynck, Frédéric Lecoche, et al.

► To cite this version:

Anne Le Mouel, Gilbert Schmitt, Maxime Dupont, Charles Joubert, Menad Bourkeb, et al.. Fostering Energy Efficiency in manufacturing plants through economical breakthroughs in power and flow rate measurement. ECEEE'12 Summer Study on Industry, Sep 2012, Arnhem, Germany. CD-ROM Proceedings (14 p.). hal-00742254

HAL Id: hal-00742254

<https://hal-centralesupelec.archives-ouvertes.fr/hal-00742254>

Submitted on 16 Oct 2012

HAL is a multi-disciplinary open access archive for the deposit and dissemination of scientific research documents, whether they are published or not. The documents may come from teaching and research institutions in France or abroad, or from public or private research centers.

L'archive ouverte pluridisciplinaire **HAL**, est destinée au dépôt et à la diffusion de documents scientifiques de niveau recherche, publiés ou non, émanant des établissements d'enseignement et de recherche français ou étrangers, des laboratoires publics ou privés.

Fostering Energy Efficiency in manufacturing plants through economical breakthroughs in power and flow rate measurement

Anne Le Mouel, EDF R&D
Eco-Efficiency & Industrial Process Department
Site des Renardières
Avenue des Renardières – Ecuelles
77 818 Moret sur Loing Cédex, FRANCE
Email: anne.le-mouel@edf.fr

Gilbert Schmitt, EDF R&D
Eco-Efficiency & Industrial Process Department
Site des Renardières
Avenue des Renardières – Ecuelles
77 818 Moret sur Loing Cédex, FRANCE
Email: gilbert-m.schmitt@edf.fr

Maxime Dupont, EDF R&D
Eco-Efficiency & Industrial Process Department
Site des Renardières
Avenue des Renardières – Ecuelles
77 818 Moret sur Loing Cédex, FRANCE
Email: maxime-2.dupont@edf.fr

Charles Joubert, AMPERE Laboratory
Bâtiment Oméga
43, Boulevard du 11 novembre 1918
69622 VILLEURBANNE, FRANCE
Email: charles.joubert@univ-lyon1.fr

Menad Bourkeb, AMPERE Laboratory
Bâtiment Oméga
43, Boulevard du 11 novembre 1918
69622 VILLEURBANNE, FRANCE
Email: menad.bourkeb@gmail.com

Olivier Ondel, AMPERE Laboratory
Bâtiment Oméga
43, Boulevard du 11 novembre 1918
69622 VILLEURBANNE, FRANCE
Email: olivier.ondel@univ-lyon1.fr

Caroline Coutier, CEA / LETI
MINATEC Campus
17 Rue des Martyrs
38054 GRENOBLE, FRANCE
Email: caroline.coutier@cea.fr

Lionel Duvillaret, KAPTEOS
Bâtiment Chablais
Rue Lac de la Thuile - Savoie Technolac

73376 LE BOURGET-DU-LAC Cedex, FRANCE
Email: lionel.duvillaret@kapteos.com

Yann Gaeremynck, KAPTEOS
Bâtiment Chablais
Rue Lac de la Thuile - Savoie Technolac
73376 LE BOURGET-DU-LAC Cedex, FRANCE
Email: yann.Gaeremynck@kapteos.fr

Gwenaël Gaborit, KAPTEOS
Bâtiment Chablais
Rue Lac de la Thuile - Savoie Technolac
73376 LE BOURGET-DU-LAC Cedex, FRANCE
Email: Gwenaël.Gaborit@kapteos.fr

Frederic Lecoche, KAPTEOS
Bâtiment Chablais
Rue Lac de la Thuile - Savoie Technolac
73376 LE BOURGET-DU-LAC Cedex, FRANCE
Email: frederic.lecoche@kapteos.fr

Erik Etien, LIAS
Bâtiment B25
2, Rue Pierre Brousse- BP 633
F86022 POITIERS Cedex, FRANCE
Email: erik.etien@univ-poitiers.fr

Baya Hadid, LIAS
Bâtiment B25
2, Rue Pierre Brousse- BP 633
F86022 POITIERS Cedex, FRANCE
Email: baya.hadid@etu.univ-poitiers.fr

Régis Ouvrard, LIAS
Bâtiment B25
2, Rue Pierre Brousse- BP 633
F86022 POITIERS Cedex, FRANCE
Email: Régis.Ouvrard@univ-poitiers.fr

Thierry Poinot, LIAS
Bâtiment B25
2, Rue Pierre Brousse- BP 633
F86022 POITIERS Cedex, FRANCE
Email: Thierry.Poinot@univ-poitiers.fr

Jean-Marc Moser, SOCOMEC
Service Recherche Industrielle Appliquée
Rue de Westhouse
BP 60010
67235 BENFELD Cedex, FRANCE
Email: jean-marc.moser@socomec.com

Christian Kern, SOCOMEC
Service Recherche Industrielle Appliquée
Rue de Westhouse
BP 60010
67235 BENFELD Cedex, FRANCE
Email: Christian.Kern@socomec.com

Laurent Lebrusquet, SUPELEC

Département SSE
Plateau de Moulon
3, rue Joliot-Curie
91192 GIF-SUR-YVETTE, FRANCE
Email: Laurent.Lebusquet@supelec.fr

Abstract

The ability to measure, monitor and control energy consumption at several key locations in a manufacturing plant is a major prerequisite for any efficient energy management program. To identify and evaluate energy savings, one must get a clear view of how the energy is used. Furthermore, measuring energy flows is one of the necessary conditions for long lasting energy-efficient solutions. Most of the time energy managers are reluctant to put in place power and flow rate measuring devices either because of their cost or because this implies disrupting production.

To find acceptable and economical solutions for long lasting energy measurements in Industry, EDF R&D launched a 3-year collaborative research project called CHIC. This project is funded by the French National Research Agency (ANR) and involves 7 partners. Its total budget amounts to 2.55 M€.

Because energy measuring devices acceptability relies mostly on their ability to be installed without disrupting production as well as on their installation and maintenance costs, two non intrusive and low cost technologies will be explored within the project:

- A physical approach is being used to build a clamp-on power meter that could be installed around multi-conductors power cables without interrupting power supply,
- A software based approach is being used to build power and flow meters that derive the sought-for variable from models and from simple and easy to collect other physical measurements (e.g. command signals, etc...).

Introduction

In France, the energy consumption of the industrial sector amounts to 470 TWh (70% of which being devoted to satisfy heating requirements). This represents roughly 28% of the French energy consumption and 23 % of its total CO₂ emissions (30 Mt/year). Part of this energy could have been saved without disrupting production nor breaching any safety rule nor impacting operators working environment. Part of this energy was wasted because it was used for purposes unnecessary for production and nobody noticed.

Too many times, when production is stopped (during holidays or week-ends) the energy consumption of a manufacturing plant remains high, although nothing going on within the plant requires it. Such a situation is not an energy efficient one and it can last for a long time if nobody bothers to measure and analyse the site energy consumption throughout a long period of time. Similarly, energy is often wasted with several manufacturing supporting services that provide compressed air, heat and cold to the plant. For compressed air systems for instance, if there is an air leak somewhere, as long as the compressors are powerful enough, there will be enough compressed air for the manufacturing processes. Plant operators will get the compressed air they need and they won't complain. Nobody in the plant will think there is a default somewhere in the system and nobody will bother looking for air leaks. Nevertheless, the compressed air system will consume a lot of energy, in fact much more than it is supposed to. The air linkage could be revealed when measuring both the compressors energy consumption and the compressed air flow rate.

There exists a strong potential for energy savings within the French manufacturing industry, probably equally in the European one. This potential is yet to be revealed and exploited.

Implementing Energy Efficiency improvement programs

Nowadays there exist one international standard and a Measurement and Verification (M&V) protocol that can be used as a methodology framework to implement Energy Efficiency improvement programs.

EN and ISO standards for Energy Management Systems

The international standard that can provide guidelines is the international ISO 50001 "Energy Management Systems" standard, published in June 2011, coming after the previous European EN 16001 Standard, published in July 2009.

The ISO 50001 standard is the result of a collaborative effort of 61 countries, including countries from the European Committee for Standardization that published the EN 16001 standard. The EN 16001 standard has now disappeared to the benefit of the ISO 50001 standard.

The ISO 50001 standard specifies requirements for an energy management system that is based on a continuous improvement principle: Plan – Do – Check – Act and then Plan – Do – Check – Act, etc...:

Plan: determine the main energy consuming systems and establish performance targets for it,

Do: install a metering and monitoring system,

Check: compare the measured energy performance to the targeted one,

Act: identify corrective actions and implement Energy Efficiency improvement programs.

The ISO 50001 standard is similar to the EN 16001 standard in the sense that both use a preliminary energy audit to determine the main energy consuming systems of the plant, and both require setting performance targets for those systems and implementing metering and monitoring devices to check that these performance targets are respected.

The International Performance Measurement and Verification Protocol (IPMVP)

The International Performance Measurement and Verification Protocol was first released in 1996 and has evolved ever since. It is free to download from the Efficiency Valuation Organization (EVO) web site (<http://www.evo-world.org/>). EVO is a non-profit organization “dedicated to creating Measurement and Verification tools to allow efficiency to flourish”.

“The IPMVP is intended to be used by professionals as a basis for preparing savings reports. Each user must establish its own specific M&V (Measurement and Verification) Plan that addresses the unique characteristics of the project” (Preface of IPMVP Volume 1, 2007).

This protocol presents a framework and defines the terms that are to be used for determining the savings one should expect after implementing an Energy Efficiency improvement program. It specifies the topics to be addressed in a Measurement and Verification Plan for a specific program. The protocol allows flexibility in creating M&V programs, as long as these programs respect the principles of: accuracy, completeness, conservativeness, consistency, relevance and transparency.

IPMVP focuses on three major issues which are: defining Performance, Performance Measurement and Performance Verification.

Defining Performance is a prerequisite. Performance can be defined at the plant level or at an intermediate level according to the Energy Efficiency improvement program that is to be implemented. For instance, if a compressed air system is to be refurbished, then the protocol can only focus on that specific compressed air system.

Performance Measurement requires installing measuring devices wherever needed, which depends on the Performance Verification protocol that will be used.

Performance Verification is the trickiest part of the protocol, since it is impossible to measure energy savings per se. Only energy consumption can be measured. It has to be compared to forecasted energy consumption in order to estimate how much energy has been saved. According to the protocol, the forecasted energy consumption will be calculated using a baseline / reference energy consumption and several adjustment factors that have to be defined. Typical adjustment factors would be the production load factor, the outside temperature, etc...

IPMVP is meant to be used as a “quality management system” for energy savings assessments related to Energy Efficiency improvement programs. Many documents and organizations in the world suggest the IPMVP for use in programs or as a reference for good practice (the EVO web site presents a list of such documents and organizations).

Cost-benefit analysis for Energy Efficiency improvement programs

The ISO 50001 standard, combined with the International Performance Measurement and Verification Protocol provide plant energy managers with a general methodology. What needs to be done at the plant level is to define precisely an Energy Efficiency improvement program according to the plant energy characteristics. It will be up to the plant energy manager to define his / her own Performance criteria, and his / her own Performance Measurement and Verification methodology according to the program he / she intends to implement. Although that is not an easy task, defining Performance criteria and a M&V methodology is not what usually prevents the implementation of Energy Efficiency improvement programs.

Within the industrial sector, every investment program, and especially an Energy Efficiency improvement one, is accepted according to its cost-benefit analysis. The costs of an Energy Efficiency improvement program must be balanced with its benefits. Sometimes, a project with an acceptable cost-benefit ratio is rejected based on the amount of its upfront capital costs. There are two main reasons for such a rejection: investment budgets are limited and Energy Efficiency may not be a priority at that moment.

Furthermore, most of the time, the implementation of an Energy Efficiency improvement program disrupts production, which is seen as an additional cost that is usually not acceptable.

There are several ways to foster the acceptance of Energy Efficiency improvement programs: one way would be to find solutions that do not disturb production, another would be to decrease programs costs and to increase their benefits.

What motivated the CHIC research project?

The CHIC project emerged from the continuous awareness that measuring is the key for improving Energy Efficiency in the manufacturing sector and that the installation of measuring devices is still unacceptable for most plant managers, either because this disrupts production or because of its cost.

Measuring is the key for improving Energy Efficiency in the manufacturing sector

Whatever the industrial sector considered (food, cement, metal ...), the optimisation of a manufacturing plant is a complex process that requires monitoring. One cannot optimize what he / she does not know. To identify and evaluate energy savings, one must get a clear view of how the energy is used. As stated in both the ISO 50001 and the EN 16001 standards, measuring is the first step towards energy consumption awareness and thereafter Energy Efficiency. The ability to measure, monitor and control energy consumption at several key locations in a manufacturing plant is a major prerequisite for any efficient energy management program.

Furthermore, all manufacturing plants are continuously evolving and what may be optimized at one moment may not stay optimized for a long time. Once again, measuring is the key to maintain Energy Efficiency throughout time. Energy savings programs, when their impacts are not continuously measured, prove themselves inefficient in the long – or even short – term. Usually several months is a period of time long enough to get into a non optimized situation again. Therefore, continuously measuring energy flows is one of the necessary conditions for long lasting energy-efficient solutions.

N.B. In the manufacturing industry, two different types of energy consumption must be distinguished: the one related to the process itself and the one related to the systems that deliver compressed air, vapour, cold water, etc... through the plant. Whereas it is generally very difficult to modify the energy consumption related to a manufacturing process, because this might have a strong impact on production, it is most of the time much easier to optimize auxiliary energy consumption, as long as it is well known and understood and therefore well measured.

What should be measured?

IPMVP focuses on energy savings and therefore on energy consumption. But measuring energy consumption is not enough. The influential factors used to calculate energy savings should also be measured.

Other parameters should also be measured in order to get some ratios that can be compared either from one site to another or from one system to another. For instance, for a compressed air system, it could be interesting to measure its energy efficiency in terms of Wh / Nm³ of air. For the glass Industry, it could be interesting to measure how much energy is consumed to get a ton of melted glass: the ratio to monitor would then be in terms of kWh / ton of melted glass, etc...

Within an Energy Efficiency improvement program, many variables may be measured. Most of them are physical variables, such as power, flow rates, manufacturing production, temperatures etc... All those variables can be measured by actual commercial sensors or meters.

Why do we lack measurement?

Not every measurement is problematic. Some physical parameters, such as temperatures, are easy and not expensive to measure. On the contrary, power and flow rates are either rather expensive or totally impossible to measure, especially if the plant is already in operation.

To measure power for instance, one must cut the power off, for safety reasons, which may disrupt production. To measure flow rates, one can use some regular flow meters which installation requires cutting through the pipes.

This once again may disrupt production. For many manufacturing plants, it is too costly - which means it is not possible - to stop production to install measuring devices.

There exists another way to measure flow rates, which is a non intrusive one, and therefore it does not disturb production. The solution is to use meters based on ultrasound technology. These meters are seen as very expensive and therefore are only dedicated to time-limited energy audits. Nowadays, there is no commercial non intrusive measuring device for power.

What penalizes measurements is not technology. It is costs. IPMVP suggests an additional cost for measuring of less than 10 to 15% of the program total energy savings. What penalizes measurements is the additional cost of disrupting production during the installation of the meters, which is most of the time way above the recommended 10 to 15%.

The CHIC research project

CHIC is a French acronym for “CHaîne de mesures Innovantes à bas Coût”, which means: innovative low cost measuring systems.

The CHIC research project was launched in January of 2010 in order to tackle measuring issues in manufacturing plants. It is a 3-year project funded by the French National Research Agency (ANR). It involves 7 partners: EDF R&D, AMPERE, LIAS, CEA-LETI, Kapteos, SOCOMEC and SUPELEC. The total budget of the project amounts to 2.55 M€.

As stated above, not every measurement is problematic. The CHIC research project only deals with:

- power measurements for three-conductor power cables,
- flow rate measurements.

N.B. These measurements are the most popular ones within the energy plant manager community, which are really eager to get values, and the most unpopular ones within the plant manager community because of their installation consequences.

The CHIC research project focuses on creating and experimenting new solutions that will be:

- non intrusive,
- low cost,
- plug and play,
- low energy consumption systems,
- efficient and robust, even with noise and perturbations.

New measuring devices will be developed during the CHIC research project, one of them being a physical clamp-on power meter, while the others are “software based meters” - as opposed to “physical meters” -, because they derive their measurement from mathematical models and from simple and easily measurable other physical variables (like command signals for instance). The following meters will be developed during the CHIC project (see later for details):

- a physical clamp-on power meter that could be installed around three-conductor electrical cables anywhere in the plant,
- a software power meter, for industrial electrical furnaces, that will derive power from the furnace command signal,
- a software compressed air flow meter, that will derive the air flow rate from the compressor consumed power,
- a software gas flow meter for boilers, that will derive the gas flow rate from its inlet valve opening position.

N.B. Every CHIC software meter must be dedicated to a specific equipment because it relies on extra variables and on mathematical models that are strongly dependant on the physics involved.

The four different prototypes realized within the project will be tested on EDF R&D premises so as to validate their use in manufacturing plants. Three EDF R&D laboratories will be used for the tests, each of them being dedicated to equipments that can be found in Industry: chillers, electrical furnaces and gas boilers. CHIC measuring devices will be tested on a 75 kW chiller, on a 146 kW electrical furnace and on a 750 kW gas boiler. The EDF R&D research Centre of Les Renardières near Paris has also a dedicated compressed air station, which supplies EDF R&D laboratories. This compressed air station will also be used for the tests.

The facilities used to test the project prototypes are similar to those found in most French manufacturing plants. They may be a little less powerful, but they will allow testing CHIC measuring devices in real and industry-like operating situations (with noise, perturbations etc...). Tests will begin in 2013.

State of the art for power and flow rate measurements

Methodologies and costs for power and flow rates measurement with actual commercial devices were investigated at the beginning of the project. Our main findings are presented below.

Measuring power for three-conductor power cables with actual commercial devices

Methodology

Nowadays there exist a lot of commercial devices that can be used to measure power for three-conductor power cables. They all use the same methodology.

Today's energy meters need to calculate power from the conductors current and voltage values, therefore the need to measure three currents and three voltages. This can only be done inside an electrical distribution box, where the conductors of the power cable are separated. Voltages are measured with probes directly connected to the conductors. Currents are measured by installing around each conductor a current transformer. Such devices reproduce the current that flows through a conductor at a much lower scale. Examples of devices that can be used to measure currents in one conductor are given in (Ripka 2010). Measuring power for a three-conductor power cable means installing three voltage probes and three current transformers inside the electrical distribution box and connecting all six to an electrical energy meter (see below for a schematic description of power measurement with actual commercial devices). For safety reasons, it is mandatory to cut power when installing the current transformers and the voltage probes inside the electrical distribution box.

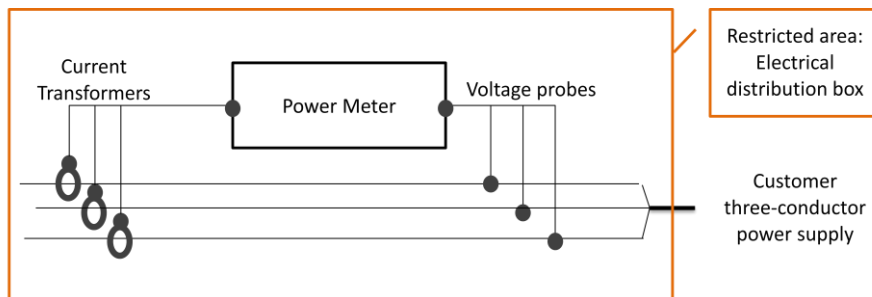

Figure 1. Measuring power with today commercial metering devices.

The main disadvantages of this solution are:

- for safety reasons, to install all voltage probes and current transformers, power must be cut off, which means stopping all electrical devices that are connected to the distribution box where the meter is installed,
- only authorized and specifically trained personnel can open an electrical distribution box, which means that the labour costs of the measurement is relatively high.

These two major disadvantages induce most of the time high rejection rates.

Costs

One of the first tasks of the CHIC project was to quantify the cost of power measurements with actual commercial energy meters over a 20 years period of exploitation (such a long period have been chosen because it matches the exploitation expectancy of the meters). The calculations were based on typical electrical installations often found in French manufacturing plants. Those include 8 levels of current (from 60 A to 1500 A), each of them being monitored. The total cost of the monitoring system that should have been put in place on those typical electrical installations has been calculated and then divided by 8 to retrieve the average cost for one power measurement. Two types of current transformers were used for the calculations: one of them being a standard one, and the other one, more expensive, being designed for retrofit operations because it can be opened (its installation is therefore easier but nevertheless requires cutting off power). The results are showed in the table below:

Table 1. Average costs for power measurement for one three-conductor electrical cable with today commercial meters over a 20 years exploitation period.

	Standard energy meter (using three standard current transformers)	Retrofit energy meter (using three current transformers that can be
--	---	---

		opened which decreases installation time but nevertheless requires cutting off power)
Average costs for power measurement on one three-conductor cable (current ranging from 60A to 1500A in each phase): sum of purchase, installation and maintenance costs over a 20 year exploitation period (no interest rate).	1 409 €	1 726 €
Total amount of time during which power must be cut off to provide safety for the electrician who installs the meter.	96 h	32 h

N.B. All actual technologies require cutting power during the installation of the current transformers and the voltage probes, for safety reasons, which is most of the time, not acceptable.

Measuring flow rates with actual commercial devices

Methodology

Two types of actual commercial flow meters were evaluated at the beginning of the CHIC project:

- a standard electromagnetic flow meter that is very common in manufacturing plants (see figure below), and that needs cutting the pipe to be installed (the same evaluation could have been done with other types of intrusive flow meters (Coriolis, Vortex, etc...) – whatever the technology used, the results would be similar),
- a non intrusive flow meter that is based on ultrasound technology, which installation does not need cutting the pipe (see figure below). Taking the meter off the pipe does not require cutting the pipe either.

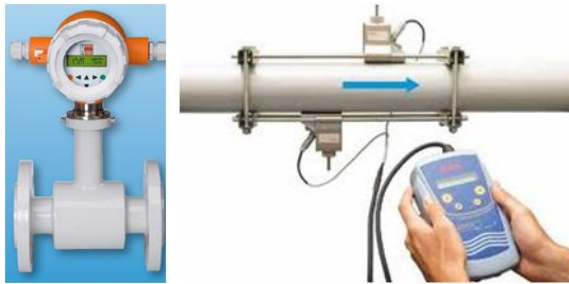

Figure 2. *On the left: standard commercial electromagnetic flow meter; on the right: measuring flow rates with an ultrasound flow meter.*

Costs

The total costs for flow rates measurement with these two commercial devices have been evaluated for an exploitation period of 10 years. The assumptions for the pipe and operating conditions were as follows: the diameter of the pipe was of 80 mm, the fluid flowing in the pipe was water, its pressure was below 10 bars, its temperature was comprised between 60°C and 80°C, the speed of the water was of about 7 m/s. The assumptions for the maintenance of the meters were as follows: the standard electromagnetic flow meter needs maintenance every year, which requires emptying the pipe and sending the meter for checking (the total labour costs for taking the meter off the pipe and putting it back again on the pipe is of at least 2h per year), the ultrasound meter needs maintenance every 5 years, which requires sending the meter for checking (the total labour costs for taking the meter off the pipe and putting it back again on the pipe is on average of 15 min per year). The results of this analysis are showed in the table below:

Table 2. Total costs for flow rate measurements with today commercial products over a 10 years exploitation period.

	Standard electromagnetic flow meter	Ultra sound flow meter
Purchase cost for one meter	500 €	5000 €
Total costs for monitoring the flow rate in one pipe: sum of purchase, installation and maintenance costs for the meter over a 10 years exploitation period (no interest rate considered).	6 540 €	5 845 €
Number of times for which the pipe must be emptied and the process stopped during the	10	0

10 years period.		
------------------	--	--

N.B. Although intrusive flow meters purchase costs are very low (there is a factor of 10 between the purchase costs of the two flow meters presented above), their exploitation costs are, over a 10 years exploitation period, at the same level as those of non intrusive flow meters. Nevertheless, ultrasound flow meters are seen as very expensive and are mostly dedicated to time-limited energy audits.

Plant managers are usually reluctant to install flow rate meters on existing and operational pipes. Different reasons explain this attitude, according to the type of flow meter:

- non intrusive flow meters are seen as too expensive,
- all other flow meters, which are intrusive, require emptying and cutting the pipe to be installed.

CHIC power meters

Costs and benefits for CHIC power meters

The targeted total exploitation costs for CHIC power meters over a 20 years period has been set to between 1 409€ and 1 726€, which is the sum of the actual purchase, installation and maintenance costs for existing commercial meters over a 20 years exploitation period.

The main advantage of CHIC power meters over the actual commercial meters will be that there will be no need to cut power to install them.

Furthermore, the following advantage is foreseen for CHIC power meters: the CHIC physical clamp-on power meter will be able to support some installation checking process because of its embedded calculations: it should be able to tell if it is correctly installed. As for the CHIC software power meter, it will obviously be installed correctly (very little mistakes can be made in getting a command signal). This would be a real technological breakthrough because, as we have seen on many manufacturing plants, roughly 30% of the installed power meters do not deliver correct values, as they are not installed properly. It takes time and efforts to make sure that the installed power meters are trustworthy. This won't be the case with CHIC power meters.

CHIC physical clamp-on power meter

As stated above there is a need for non intrusive power meters for three-conductor power cables, i.e. for power sensors that does not require having the conductors separated nor being installed inside an electrical distribution box. It was decided to build within the CHIC project a clamp-on power meter that would derive power from the measurement of the currents and voltages of the three conductors and that will be installed directly on the three-conductor power cables, wherever these are in the plant (and especially not in restricted places such as electrical distribution boxes).

Conductors' currents will be calculated from the measurement of the magnetic field that surrounds the power cable. Similarly, voltages will be calculated from the measurement of the electrical field that surrounds the power cable. Both calculations depend on the position of the conductors inside the cable. The following figure shows the inside geometry of a typical industrial three-conductor power cable:



Figure 3. Cross section geometry of a typical industrial three-conductor power cable.

A bibliographical survey carried on electrical and magnetic field measurements around power cables pointed out that the CHIC project was facing real methodological and technical challenges in that domain (D'Antona 2001), (Di Rienzo 2001), (Xiao 2003).

Many simulations were conducted in order to derive a robust methodology that could be used to derive the conductors' currents and voltages from the measurement of the magnetic and electrical fields around the power cable. For simplicity reasons only current measurements are detailed here.

In theory, the relationship between the magnetic field B around the power cable and the currents I flowing through the conductors is linear, therefore the possibility to derive the values of the currents from the measurement of the magnetic field distribution. Theoretical work has been carried out for different distributions of magnetic sensors around multi conductor cables. N magnetic sensors were considered at first. It became soon obvious that the magnetic sensors around the cable should be shielded from the influence of other cables. The

drawing on the left of the figure below represents the configuration that has been studied. The mathematical relation between the magnetic field measured in the N magnetic sensors around the cable and the values of the currents is synthesized in the equation next to it (where M conductors have been considered). To calculate the values of the currents, one needs to solve a non trivial inverse problem. The methodology used is summarized in the figure below:

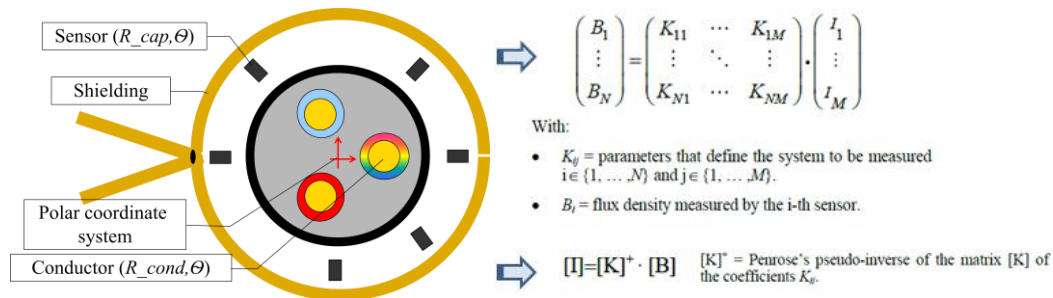

Figure 4. Calculating currents from the measurement of the magnetic field distribution around a three-conductor power cable.

The methodology presented above involves solving a non trivial inverse problem, with difficulties related to the unknown characteristics of the cable: its internal structure (distance between the conductors and the centre of the cable, conductors radii, permittivity of the insulating material) and its actual position inside the ring of magnetic sensors (more work needs to be done concerning rotating, decentring..., effects of the cable). A more detailed description of the work done within the CHIC research project can be found in (Menad 2011) and (Menad 2012).

It is foreseen that the CHIC physical clamp-on power meter will look as shown in the following figure:

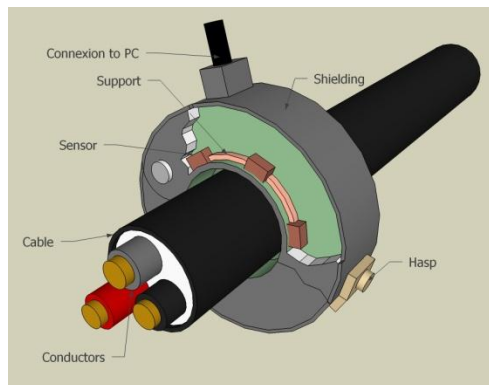

Figure 5. Measuring power with CHIC physical clamp-on power meter.

Although a solid theoretical background has been set for the physical CHIC power meter, much work remains to be done concerning its practical implementation. Its future geometry and its constitutive materials must be defined. A first prototype should be build before the end of 2012. This prototype will be first tested in a dedicated test bench (see picture below) before being installed and thoroughly tested on some of EDF R&D equipments.

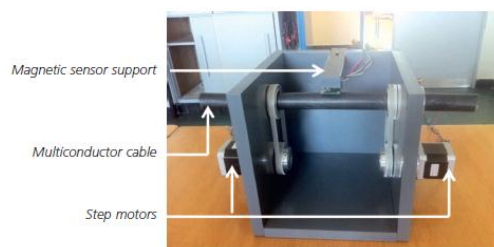

Figure 6. Test bench for the CHIC physical power meter.

CHIC software power meter for industrial electrical furnace

To complement the physical approach described above, a software approach was also investigated within the CHIC research project in order to measure power. The industrial equipment that was chosen is an electrical furnace. Industrial electrical furnaces present the following advantages:

- power is related to the command signal, which is a value that varies between 0 and 100%,

- the command signal can easily be collected from the furnace control system.

The figure below presents some of the data collected on one of EDF R&D electrical furnace. We can see that during the first part of the measurements, power is strongly related to the command signal. This is usually the case. When power is not related to the command, as shown in the figure below, it means that there is a problem with the furnace. An overshoot in power may be caused by a door that was poorly closed or by a default in one of the resistances of the furnace (as it is the case here – a set of resistances have been disconnected on purpose). It is very interesting to “see” such defaults because this would help sending warnings on the operating conditions of the furnace so as to decrease its consumed energy and to plan for its maintenance.

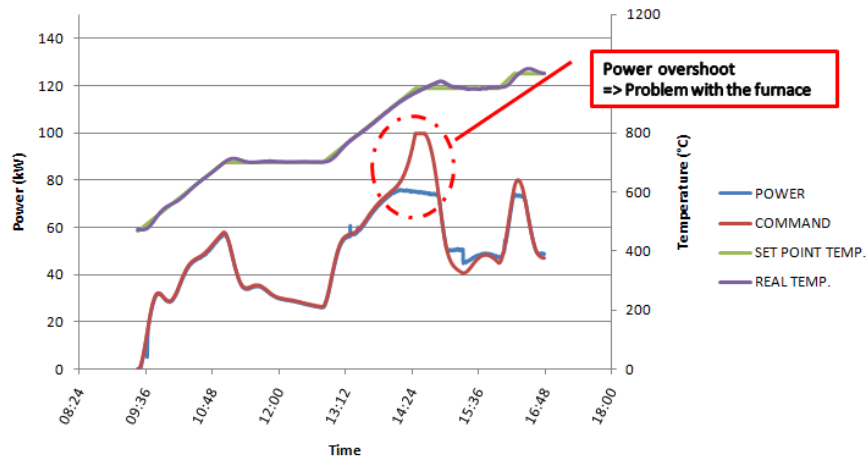

Figure 7. Power, command and inside temperature for one of EDF R&D electrical furnace.

More data is being collected from EDF R&D electrical furnaces in order to derive a robust version for a CHIC software power meter. It is foreseen that a first prototype will be operational before the end of the year 2012.

CHIC flow meters

Costs and benefits for CHIC flow meters

CHIC flow meters targeted purchase price has been set to 1 300 €, which is an intermediate value between the purchase costs of the two commercial flow meters presented above. If CHIC flow meters purchase price were too high, they will be rejected as are nowadays the ultrasound flow meters. It is foreseen that CHIC flow meters won't need a lot of maintenance, because their physical part is really small and pretty straightforward.

CHIC flow meters being software meters, and therefore non intrusive, they should be accepted fairly widely as long as their price remains within acceptable boundaries. Within the project a particular attention will be devoted to decrease as much as possible the cost of these flow meters.

CHIC software flow meter for compressed air systems

Within the French manufacturing sector, little attention is paid to compressed air systems as long as operators are getting enough air at the correct pressure. Compressed air systems energy consumption is not a priority for plant operation, although many of these systems are wasting energy. A compressed air system is a complex system in which many types of equipment are involved. Compressors play an important role, but dryers, air tanks, pipes, etc. are also to be considered when analysing the system. The figure below shows a typical compressed air system with its main components:

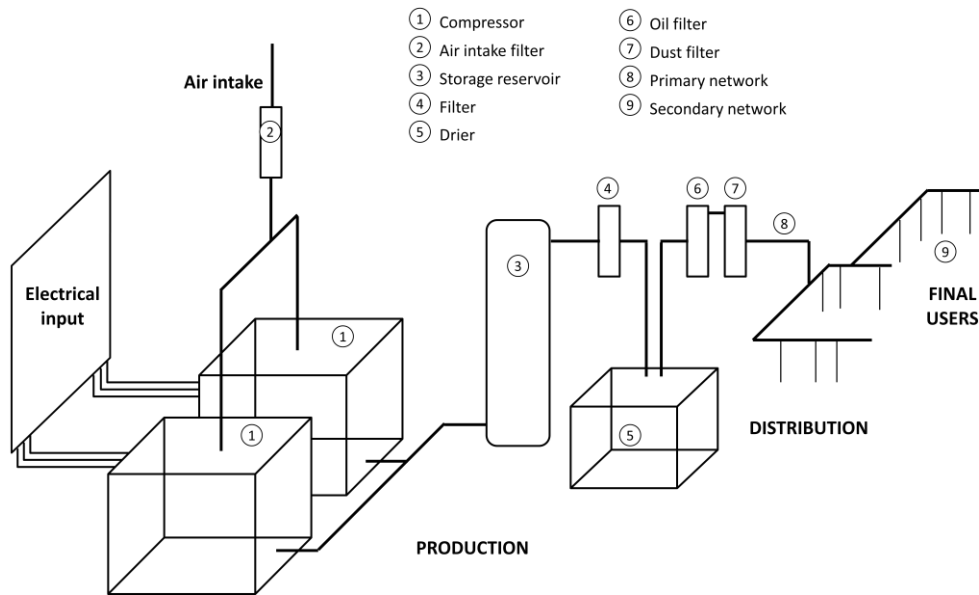

Figure 8. Typical compressed air system with its main components.

The purpose of the CHIC software flow meter for compressed air systems is to estimate the value of the compressed air flow rate produced by a compressor, based on the consumed power of the compressor and on several additional variables such as: the compressed air pressure, the intake air pressure, temperature and humidity. The EDF R&D compressed air station was used to collect data:

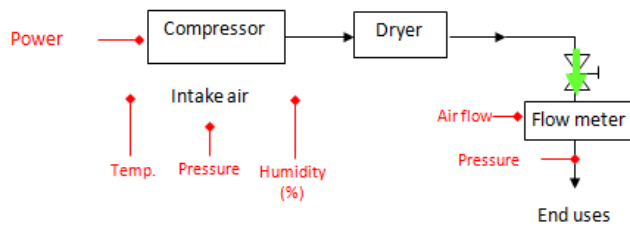

Figure 9. EDF R&D compressed air system. The data collected are in red.

CHIC software flow meter for compressed air systems will use the similarity that exists between the instantaneous compressor power and the compressed air flow rate - see the left part of the figure below:

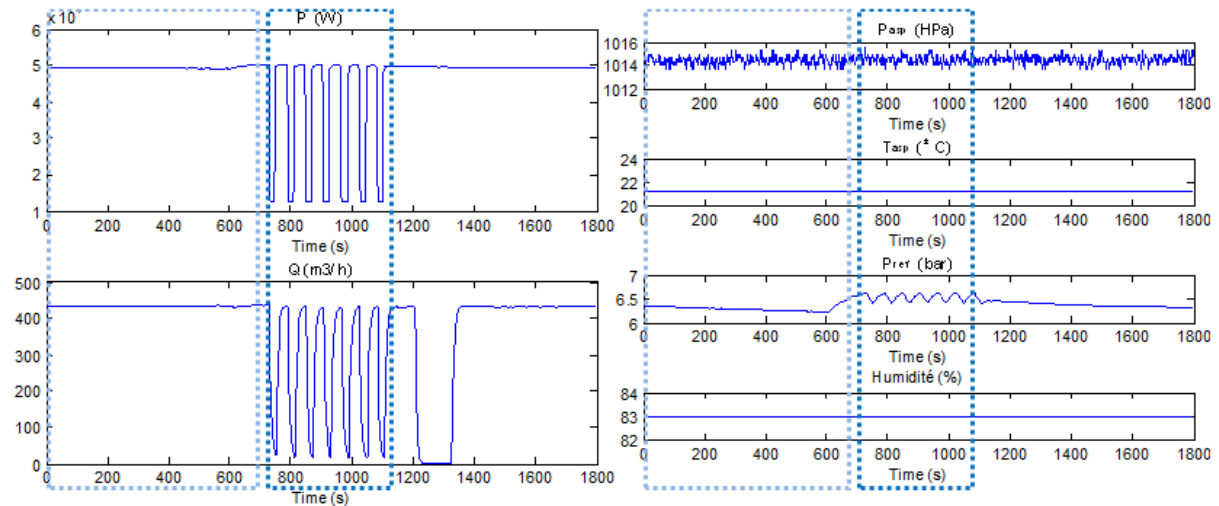

Figure 10. Relation between compressor power and compressed air flow rate (and additional parameters).

The main challenge that has to be faced here is to determine the mathematical model to be used along with its input data and its influential parameters. The CHIC software flow meter for compressed air systems will be based on the following equations:

$$P_{fluid} = eff * (P_{comp.} - P_{aux.}) = \frac{k}{k-1} P_{int. air} Q_{int. air} \left(\left(\frac{P_{comp. air}}{P_{int. air}} \right)^{\frac{k-1}{k}} - 1 \right)$$

Where P_{fluid} is the energy taken by the fluid, eff is efficiency, P_{comp} and P_{aux} are the power of the compressor and of all the auxiliary equipments, $P_{int.air}$ and $Q_{int.air}$ are the pressure and the flow rate of the intake air, $P_{comp.air}$ is the pressure of the compressed air and k is an isotropic coefficient. The three parameters eff , k and P_{aux} need to be identified properly.

The CHIC software flow meter for compressed air systems is not yet operational because in order to derive a robust model, one needs to get data for various operational conditions in terms of temperature and humidity. Since operational conditions are weather dependent, we would need roughly an entire year to collect enough data. Work is progressing and a first prototype should be operational before the end of the year.

CHIC software gas flow meter for boilers

It is usually very difficult to know the gas consumption of a given industrial gas boiler, since most of the time very few gas meters are installed on industrial sites and the ones that are installed usually measure the site total gas consumption. Once a gas boiler is operational, it is very difficult to convince a plant manager to install a dedicated gas meter because this would cost money and this would imply shutting it down. As a consequence, there is a need for low cost and non intrusive gas flow meters for boilers.

The figure below represents a typical gas boiler. Gas that enters a boiler passes through a regulating valve. It is fairly easy to collect the valve command signal (which is a value that varies between 0 and 100%). CHIC gas flow rate software meter will use the intake gas regulating valve command signal in order to derive the amount of gas that is consumed by the boiler.

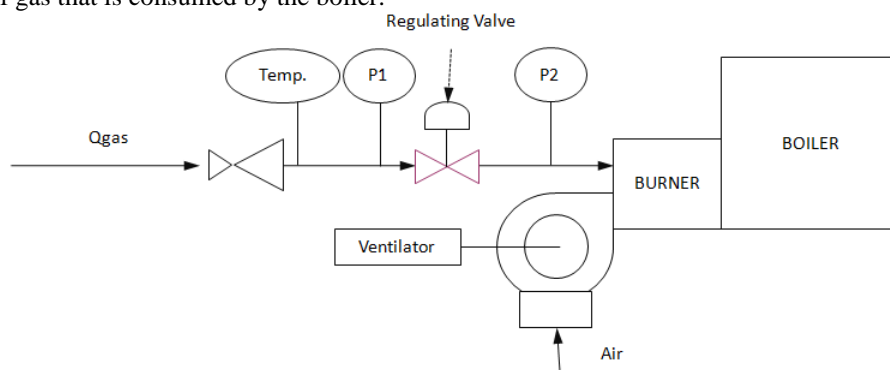

Figure 11. Typical industrial gas boiler installation.

Theoretically, the gas flow rate Q_{gas} depends on the square root of the difference of the pressures of the gas before and after the valve: $s = k * \sqrt{P1 - P2}$, k being a parameter that depends on the gas pressure and temperature. Thus, the model for the gas consumption that was derived was as follows: $Q_{gas} = A x^2 + B x + C$, x being the valve command, and A , B and C being coefficients that vary according to the gas pressure and temperature.

Data have been collected for temperatures varying between 14°C and 32°C and for pressures varying between 1.082 bar and 1.218 bar. For each set of known gas pressure and temperature, the second order model presented above gives satisfaction, with errors of less than 2%. Nevertheless, if we are to build a robust model that can be used for every set of gas pressure and temperature, we need to quantify the influence of these two parameters on the values of the A , B and C coefficients. As we have seen, the influence of the gas pressure is more important and the influence of the gas temperature, which is nevertheless not negligible.

As for the CHIC software air flow rate meter, data for different operational conditions that are weather dependent are needed in order to derive a robust mathematical model that can be used for any operating condition. Work is progressing and a first prototype will be tested in 2013.

Conclusion

The CHIC research project emerged from the continuous awareness that measuring is the key for improving Energy Efficiency in the manufacturing sector and that the installation of power and flow rates measuring devices is still unacceptable for most plant managers, either because this disrupts production or because of its cost. The main purpose of the CHIC project is to develop and test new metering devices that would be non intrusive and low cost so that more and more plant managers will be able to check on their energy consumptions and therefore continuously improve their plant Energy Efficiency.

Two different approaches are explored within the project.

A physical approach is being used to build a clamp-on power meter for three-conductor cables. We are facing real methodological and technical challenges for this meter because the signals we have to collect and analyse (the values of the magnetic and electrical field around the cable) are very weak and are easily perturbed by the cable environment and operating conditions. Furthermore, these signals need to be synchronised in order to get a value for the electrical power (the value of the $\cos(\phi)$ needs to be computed). A very important simulation work showed encouraging results and a first prototype is being built based on these results. Next year real-life tests will definitely determine if the methodology is viable or not.

A software approach is also investigated within the project. Such an approach is definitely promising, but a lot of work needs to be done in order to get robust meters that give satisfactory results in many different operating conditions.

The first CHIC prototypes should be operational by the end of the year 2012. They will be tested in Industry-like operating situations on EDF R&D premises in 2013. As for costs, there exist different technologies that can be used and it is foreseen that CHIC meters targeted manufacturing costs will be respected.

References

EVO web site: <http://www.evo-world.org/>

IPMVP Citings: http://www.evo-world.org/index.php?option=com_content&task=view&id=230&Itemid=80&lang=en

Pavel Ripka. Electric current sensors: a review. *Measurement Science and Technology*, 21 112001, 2010.

Menad Bourkeb. Techniques innovantes de mesure des courants dans un système polyphasé, Conférence Jeunes Chercheurs en Génie Electrique, 13 December 2011, Belfort, France.

Menad Bourkeb, Olivier Ondel, Charles Joubert, Laurent Morel, Riccardo Scorretti. Méthodes numériques pour la mesure de courant dans un système polyphasé , Numélec 2012. European conference on numerical methods and electromagnetism, 3-5 July, 2012, Marseille, France.

G. D'Antona, L. Di Rienzo, R. Ottoboni, and A. Manara. Processing magnetic sensor array data for AC current measurement in multicondutor systems. *IEEE Trans. Instrum. Meas.*, vol.50, No.5, pp. 1289-1295, Oct.2001.

L. Di Rienzo, R. Bazzocchi and A. Manara. Circular arrays of magnetic sensors for current measurement. *IEEE Trans. Instrum. Meas.*, vol. 50, No 5, Oct. 2001, pp. 1093-1096.

Chucheng Xiao, Lingyin Zhao, T. Asada, W.G. Odendaal, and J.D. van Wyk. An overview of integratable current sensor technologies, in *industry Applications. Conference, 2003. 38th IAS Annual Meeting. Conference Record of the*, volume 2, pages 1251-1258 vol.2, Oct. 2003.

Acknowledgements

The CHIC research project is supported by the French National Research Agency (ANR).

Glossary

EVO: Efficiency Valuation Organization

IPMVP: International Performance Measurement and Verification Protocol

M&V: Measurement and Verification