



HAL
open science

UN CADRE DE SIMULATION MULTI-ETATS POUR MODÉLISER DE LA DÉGRADATION DES COMPOSANTS DE PRODUCTION D'ÉNERGIE

Yan-Fu Li, Enrico Zio, Yan-Hui Lin, Antoine Despujols

► **To cite this version:**

Yan-Fu Li, Enrico Zio, Yan-Hui Lin, Antoine Despujols. UN CADRE DE SIMULATION MULTI-ETATS POUR MODÉLISER DE LA DÉGRADATION DES COMPOSANTS DE PRODUCTION D'ÉNERGIE. LAMBDA MU 18, Oct 2012, France. pp.1-8. hal-00744002

HAL Id: hal-00744002

<https://hal-centralesupelec.archives-ouvertes.fr/hal-00744002>

Submitted on 22 Oct 2012

HAL is a multi-disciplinary open access archive for the deposit and dissemination of scientific research documents, whether they are published or not. The documents may come from teaching and research institutions in France or abroad, or from public or private research centers.

L'archive ouverte pluridisciplinaire **HAL**, est destinée au dépôt et à la diffusion de documents scientifiques de niveau recherche, publiés ou non, émanant des établissements d'enseignement et de recherche français ou étrangers, des laboratoires publics ou privés.

UN CADRE DE MULTI-STATE SIMULATION POUR MODÉLISATION DE LA DÉGRADATION DANS LES COMPOSANTS DE SYSTEMES ENERGETIQUES

A MULTI-STATE SIMULATION FRAMEWORK FOR MODELING DEGRADATION IN COMPONENTS OF ENERGY SYSTEMS

Y.F. Li, E. Zio, and Y.H. Lin
Ecole Centrale Paris – Supelec

A. Despujols
Electricité de France R&D

Grande Voie des Vignes
92295 CHATENAY-MALABRY

1 avenue du Général de Gaulle,
92140 CLAMART

3 Rue Joliot Curie Plateau de Moulon
91190 GIF-SUR-YVETTE

Résumé

Nous illustrons un cadre pour la simulation de processus de dégradation des composants de systèmes énergétiques. Ce cadre s'articule autour d'une multi-state représentation des processus. La physique qui régissent les processus est capturée dans les taux de transition régissant le random-walk à travers les états dégradation. Le cadre de calcul repose sur une représentation de la dynamique du processus par les stochastic Petri nets, appuyés par des Bayesian networks pour capturer l'influence de facteurs externes qui sont incertains et interdépendants.

Abstract

We illustrate a framework for simulating degradation processes in components of energy systems. The logical framework revolves around a multi-state representation of the processes. The physics governing the processes is captured in the transition rates governing the random walk across the degradation states. The computational framework relies on a representation of the process dynamics by stochastic Petri nets, augmented by Bayesian networks to capture the influence of interdependent uncertain external factors.

Acronyms

BN	Bayesian network
CDF	Cumulative distribution function
CPT	Conditional probability table
CTMC	Continuous time Markov chain
DTMC	Discrete time Markov chain
MC	Monte Carlo
MSM	Multi-state model
MSPM	Multi-state physics model
NHCTMM	Non-homogenous continuous time Markov model
PDF	Probability density function
PN	Petri-net
SPN	Stochastic Petri net

Notations

S	The vector of component degradation states
t	Time
$\phi(t)$	The discrete function representing the stochastic degradation process, which takes values from S
$M + 1$	The total number of component degradation states
$P(t)$	The vector of component state probability at time t
$\lambda_{i,j}(t, \theta)$	The transition rate from state i to state j at time t , given the realizations of the uncertain external influencing factors θ
θ	The vector of uncertain external influencing factors
N	The total number of transitions among the degradation states
l	The total number of influencing factors
$p(\theta)$	Probability density function of θ
p_i^{PN}	Place i of the Petri nets
t_j^{PN}	Transition j of the Petri nets
Δt_i	The holding time at state i
$F_i(t t', \theta)$	Cumulative distribution function of departure time t from state i , given t' and θ
$q_{i,j}(t \theta)$	The transition probability from state i to state j at time t given θ

Introduction

Most components and systems degrade over time before they are completely failed or exhausted. The component degradation processes have been intensively studied in the reliability engineering community (Elsayed and Liao, 2004, Lawless and Crowder, 2004, Gebraeel et al., 2009, Zio and Zoia, 2009). In general, the degradation models can be classified into analytical models (Elsayed and Liao, 2004, Lawless and Crowder, 2004, Gebraeel et al., 2009, Chryssaphinou et al., 2011) and simulation models (Hosseini et al., 2000, Barata et al., 2002, Zio and Zoia, 2009). The analytical degradation models can be further classified into the following three groups:

- Statistical models of time to failure (e.g. lifetime distribution (Gebraeel et al., 2009)).
- Models describing the evolution of a measurable quantity indicating time-dependent degradation, and failure upon reaching a threshold value (e.g. Brownian motion (Elsayed and Liao, 2004) and gamma process (Lawless and Crowder, 2004)).
- Multi-state models of degradation (Chryssaphinou et al., 2011).

Multi-state models (MSM) (Kuo and Zuo, 2003) are frequently applied for component degradation process modeling, since they fit practically to component aging processes in real life situations when there is a range of levels from perfect functioning to complete failure. To model the dynamics of the degradation processes, Markov (Chana and Asgarpoor, 2006) and semi-Markov models (Kim and Makis, 2009) have been used, whose transition rates need to be estimated from the field data. In practice, it can be difficult or even impossible to collect sufficient, relevant data especially for highly reliable devices like those employed in the nuclear industry. A novel approach based on multi-state physics modeling (MSPM) has been proposed (Unwin et al., 2011), in which the transition rates are described by physics functions of influencing factors rather than estimated from service data. The resulting model can be non-Markovian if the transition rates are time-dependent and uncertain.

MSPM is powerful when the physics functions are provided. Due to limited information, in some real world applications the relationships between transition rates and the influencing factors can only be estimated by expert judgments with certain degrees of uncertainties. Therefore, it is necessary to establish an effective methodology capable for handling information of different nature, e.g. statistical data, physical functions and expert judgments, with the related uncertainty.

In this work, we propose an integrated framework for modeling stochastic degradation processes in components of energy systems, which combines stochastic Petri nets (SPNs) for describing the dynamic transition process, and Bayesian networks (BNs) for representing the uncertain influencing factors and the possible interdependencies among them. A Monte Carlo (MC) simulation algorithm is proposed to realize the integration and compute the state probability distributions. The rest of the paper is organized as follows. Section 2 introduces SPNs and BNs. Section 3 presents the integrated framework and the detailed MC simulation procedures of the integrated model. In Section 4, the real-world case study from (Unwin et al., 2011) is used as an application. Section 5 concludes the work and points out possible future extensions.

Stochastic Petri Nets and Bayesian Networks

2.1 Stochastic Petri nets

A Petri net (PN) is a bipartite directed graph with two types of nodes in which abstract objects (tokens), drawn as bold-faced dots, are moved, created or diminished (Petri, 1966). The two types of nodes are: places (states) p_i^{PN} ($i = 0, \dots, M$), which are circular and usually denote the states of the system being modeled, and transitions t_j^{PN} ($j = 1, \dots, N$), which are bars and denote the transitions corresponding to actions or events that result to a state change. Places are linked only to transitions using directed arcs $a_{p_i^{PN} t_j^{PN}}$, and vice versa. It is possible for a place to have multiple arcs to or from the transition, which can be condensed down to a single arc with a weight or multiplicity denoted by a slash through the arc with a number next to it. If there is no slash, the weight is usually assumed to be 1 (it is also the default weight value).

The tokens, which represent objects in the model, are stored in places. The transition t_j^{PN} is enabled only if the weight of each incoming arc is equal to or less than the number of tokens at the corresponding input place. In original PNs, the transitions are assumed to be instantaneous. The stochastic Petri nets (SPNs) introduce delays of a transition which can be instantaneous, deterministically time-delayed, or randomly time-delayed dependent on a pre-defined probability distribution. Once the time period has passed and the transition remains enabled, the switching will take place. The switching will destroy the number of tokens in each input place corresponding to the weight of the relevant incoming arcs and create the number of tokens in each output place corresponding to the weights of the relevant outgoing arcs. An example of enabled transition switching is illustrated in Fig. 1.

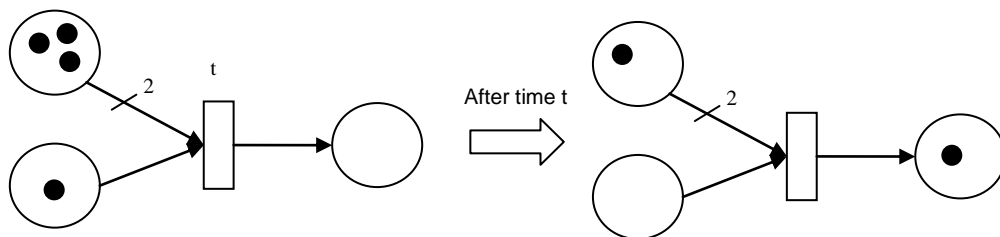

Figure 1. Basics of Petri nets: transition enabling and switching.

The state corresponding to a PN is called a marking and represents the number of tokens in each place. The initial marking represents the initial state. Several transitions can be enabled in a marking and any successful switching of transitions leads to a new marking. The SPN is often used as a modeling preprocessor (or representation tool): it can be internally converted to a continuous time Markov chain (CTMC) for solution when the time delay at each transition follows an exponential distribution (Trivedi, 2002); the Monte Carlo (MC) simulation is used to solve the SPN directly when the use of arbitrary time delay distributions is required (Dutuit et al., 1997). For the MSPM formulation embraced in this study, MC simulation is used to solve the SPN.

2.2 Bayesian networks

Bayesian networks (BNs) have become a standard tool for uncertainty modeling in reliability engineering and risk analysis research. The BN is a directed acyclic graph where the nodes represent the random variables, and the edges represent the dependencies or the cause-effect relationships among the variables. A BN represents the probability density function of a set of l random variables (or uncertain physical factors in MSPM) $\theta = (\theta_1, \dots, \theta_l)$ by specifying a set of conditional independence statements together with a set of conditional probability functions (CPFs). The CPFs are provided in the conditional probability table (CPT).

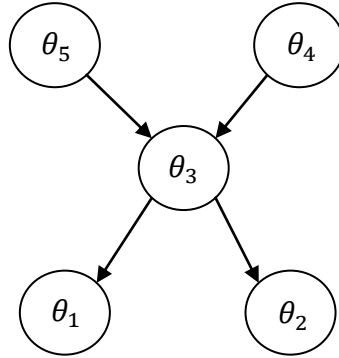

Figure 2. An example BN over the nodes $(\theta_1, \theta_2, \theta_3, \theta_4, \theta_5)$.

Each variable (or node) can be described by the probability density function (PDF) of itself given its parents in the graph, i.e. $p(\theta_i | pa(\theta_i))$, where $pa(\theta_i)$ is the set of the parent nodes of θ_i . Given the independency relations in the graph G , the joint probability density function of the set of random variables θ can be written as a product of the individual density functions as:

$$p(\theta) = \prod_{i=1}^l p(\theta_i | pa(\theta_i)) \quad \{1\}$$

where l is the total number of physical factors.

The Integrated Simulation Model for Component Degradation

3.1 The integration of stochastic Petri nets and Bayesian networks

The MC simulation of SPN models provides the flexibility to describe arbitrary firing delays. Give the general form of the transition rate

$$\lambda_{i,j}(t, \theta) = \lim_{\Delta t \rightarrow 0} \frac{\Pr(\vartheta(t+\Delta t)=j | \vartheta(t)=i, \theta)}{\Delta t} \quad \{2\}$$

where $\vartheta(t)$ is a discrete function representing the stochastic degradation process and taking values from the state space S , the total rate of departure from state i is:

$$\lambda_i(t, \theta) = \sum_{j \neq i}^M \lambda_{i,j}(t, \theta) \quad \{3\}$$

By the deductions presented in our paper (Li et al., 2012), the CDF of departure time t given that it is at state i at time t' is written as:

$$F_i(t|t') = \int F_i(t|t', \theta) p(\theta) d\theta = 1 - \int \exp\left[-\int_{t'}^t \lambda_i(t'', \theta) dt''\right] p(\theta) d\theta \quad \{4\}$$

Given t' and {4}, the departure time t can be sampled through direct inversion sampling, acceptance-rejection sampling, and other sampling techniques (Rubinstein and Kroese, 2009). Following the departure, the marginal transition probabilities to any other state $j = \{0, \dots, M | j \neq i\}$ are calculated as:

$$q_{i,j}(t) = \int \frac{\lambda_{i,j}(t,\theta)}{\lambda_i(t,\theta)} p(\theta) d\theta \quad \{5\}$$

and a uniformly distributed random number U is sampled in the interval $[0,1]$: if $\sum_{k=0}^{j^*-1} q_{i,k}(t) < U < \sum_{k=0}^{j^*} q_{i,k}(t)$, then the transition to state j^* is activated and occurs at t units of time. After time $\Delta t_i = t - t'$ a new token will appear at place j^* and the token at place i is removed.

A graphical sketch of the integration of SPN and BN is given in Fig .3. The transition and departure rates are dependent on the values of θ which are random parameters whose distributions are described by Bayesian network models: $p(\theta) = \prod_{i=1}^l p(\theta_i | pa(\theta_i))$, where $pa(\theta_i)$ is the set of the parent nodes of θ_i and l is the total number of physical factors.

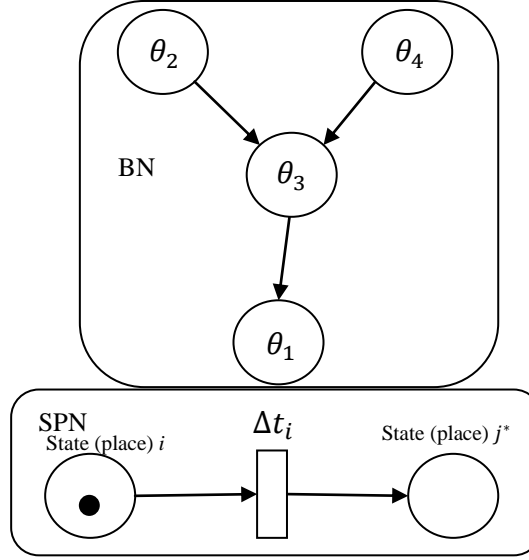

Figure 3. Sketch of the integrated model

3.2 The simulation procedure for the integrated Stochastic Petri nets and Bayesian networks

The detailed simulation procedures of the integrated model are presented in this Section. Prior to the simulation procedures, the Bayesian network needs to be built through the following steps: 1) formulate the expressions of the transition rates in terms of probability distributions, physical functions or expert knowledge; 2) identify the influencing factors θ_i (e.g. temperature, stress); 3) associate these influencing factors with proper distribution functions, $f(\theta_i)$; 4) identify the casual relationships among these factors and construct the Bayesian network.

The algorithm for the simulation of the process of component degradation on a time horizon $[0, t_{max}]$ is given in the following pseudo-code:

Initialize the system by allocating a token onto place $i = M$ (initial state of perfect performance) and setting the time $t' = 0$ (initial time)

While $t < t_{max}$

 Sample a realization of the physics factors θ from the distribution function $p(\theta)$

 Sample a departure time t from the distribution function $F_i(t|t', \theta)$

 Sample a random number U from the uniform distribution in $[0, 1]$

For each outgoing transition ($j = 0, 1, \dots, M, j \neq i$)

 Calculate the transition probability $q_{i,j}(t, \theta)$

If $\sum_{k=0}^{j^*-1} q_{i,k}(t) < U < \sum_{k=0}^{j^*} q_{i,k}(t)$

Then activate the transition to state j^*

End If

End For

 Set $t' = t$

 Remove the token from place i and add a new token onto place j^*

End While

It is noted that the derived distributions $p(\theta)$ and $F_i(t|t', \theta)$, may have complicated mathematical expressions; under these circumstances, the Markov Chain MC technique can be used to sample random values from them (Zio and Zoia, 2009).

Case Study and Results

4.1 Case study

The case study refers to the cracking process in an Alloy 82/182 dissimilar metal weld in a primary coolant system of a nuclear power plant (Unwin et al., 2011). Cracks can grow from the inner to the outer diameter of the dissimilar metal welds in one of the three major morphologies: axial, radial, and circumferential. The latter two types can lead to the rupture of the component. The crack growth has two steps (1) crack initiation, (2) crack propagation. The radial crack mainly grows outward from the initiation site towards the outer diameter; the process can lead to a leak and potentially to rupture. The circumferential crack grows relatively evenly around the circumference, potentially leading to a rupture. The transition diagram of the crack growth process is given in Fig. 4. The detailed information about the definitions of the transition rates can be found in (Unwin et al., 2011). It is noted that in their formulation, the transition rates $\varphi_1, \varphi_2, \varphi_3$ and φ_4 are time-dependent.

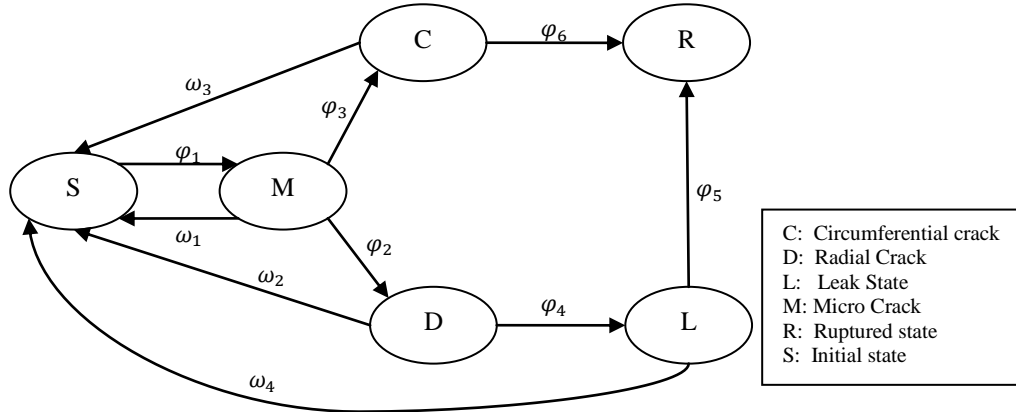

Figure 4. Markov state transition diagram the multi-state physics model of the crack growth process in Alloy 82/182 dissimilar metal weld

4.2 Results

In this Section, the PN simulation model is first applied to the case study with the parameter settings reported as in (Unwin et al., 2011). It is noted that in the original study, the uncertainties of the external influencing factors (e.g. temperature and pressure) have not been modeled in the crack initiation process and have been inexplicitly modeled in the crack propagation process by means of a uniform distribution of the transition rate $\dot{\lambda}_M$. Our simulation model has been executed $N_{\max} = 10^6$ times over a component lifetime $t_{\max} = 80$ years, in line with the original study. To investigate the convergence of the simulation model, the 10^6 realizations have been subdivided into $N = 20$ subsamples of 50000 each. The sample mean and variance of the estimated state probabilities are calculated. At $t = 80$ years, the variances are 0.6749×10^{-8} , 0.776×10^{-8} , 0.0352×10^{-8} , 0.0106×10^{-8} , 0.0037×10^{-8} , and 0.0337×10^{-8} for 'initial', 'micro-crack', 'circumferential', 'radial', 'leak', and 'rupture' states, respectively. For the comparison with the original study, the numerical results on the state probability values at year 80 are reported in Table 1. In the original study (Unwin et al., 2011), the state-space enrichment approach has been used upon discretization of the component lifetime into equally sized time steps, during each of which the transition rate remains constant. Then, the component degradation process is converted into a discrete time Markov chain (DTMC) residing in a largely enriched state space described by a tuple $S_e = (S, t_c)$, where t_c is the vector of discretized holding times at each state. The differences between the simulation and state-space enrichment method decrease as the step size in the latter is reduced. This confirms that the original method is sensitive to the step size, as expected. Both methods are implemented in the MATLAB software package.

Table 1. Comparison of simulation results with results from the original method (state probability values at year 80)

	Simulation	state-space enrichment method Time step size = 1 year	state-space enrichment method Time step size = 0.5 year	state-space enrichment method Time step size = 0.1 year
Initial state probability	0.0036	0.0033	0.0034	0.0036
Micro crack probability	0.9958	0.9963	0.9961	0.9959
Circumferential crack probability	2.72e-4	1.94e-04	2.33e-04	2.78e-04
Radial crack probability	7.78e-5	6.38e-05	6.97e-05	7.66e-05
Leak probability	1.18e-5	8.93e-06	1.06e-05	1.24e-05
Rupture state probability	2.07e-4	1.38e-04	1.73e-04	2.12e-04

As explained in Section 3, the integrated simulation framework is able to explicitly accommodate the uncertainties in the external influencing factors (it is noted that due to the limitation of data, the interdependencies in the BN are not considered in this case study). To show this, as example we assign truncated normal distributions to the temperature T and stress σ values of the Weibull scale parameter τ in the transition rate φ_1 (from initial state S to micro-crack state M) defined as:

$$\varphi_1 = \int \left(\frac{b}{\tau}\right) \cdot \left(\frac{t}{\tau}\right)^{b-1} \cdot f_{PDF}(\tau, b) d\tau db \quad \{6\}$$

where $f_{PDF}(\tau, b)$ is the joint probability density function of τ and b , and the integral is defined over the domains of τ and b . τ is a time constant which has been observed to have both a stress and temperature dependence; b is a fitting parameter. According to (Aly, 2009), τ has the following relationship with temperature and stress:

$$\tau = 9.2 \times 10^7 \times \sigma^{-7} \times \exp\left(\frac{129}{8.314 \times 10^{-3} \times T}\right) \quad \{7\}$$

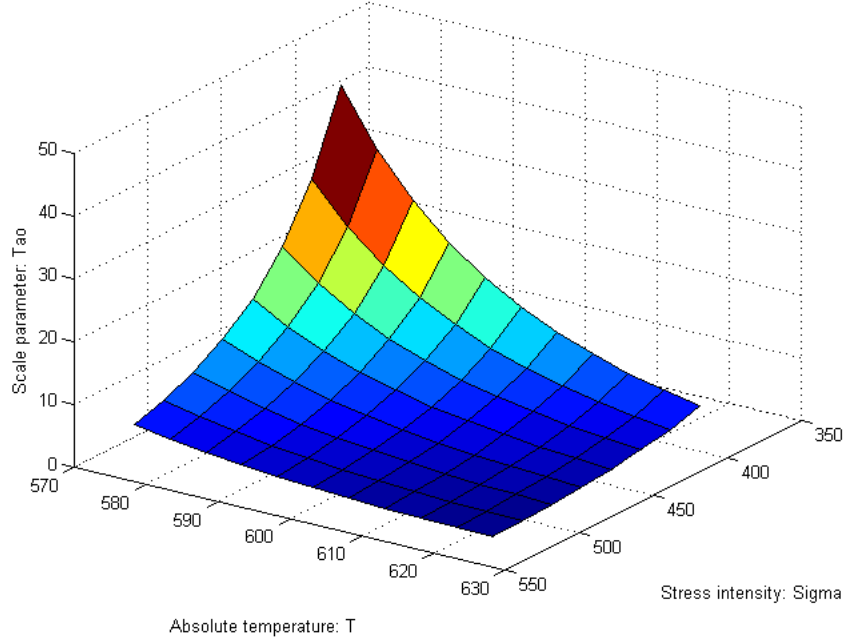

Figure 5. Function of scale parameter τ

Fig. 5 illustrates the surface plot of τ , given the range [573.15, 623.15] of T and the range [385, 535] of stress σ . These ranges are set to satisfy the maximum limit of $\tau=40$. The truncated normal distributions are defined as follows:

$$p(\sigma) = \frac{\phi(\sigma-460)}{\phi(535-460)-\phi(385-460)} \quad \{8\}$$

$$p(T) = \frac{\phi(T-598.15)}{\phi(623.15-598.15)-\phi(573.15-598.15)} \quad \{9\}$$

where $\phi(\cdot)$ denotes the PDF of a normal distribution. Without loss of generality, the variance is assumed to be 1 for the normal distributions.

The simulation results are displayed in Figures 6 and 7 for uncertain temperature and uncertain stress, respectively, in terms of mean values of the state probabilities (solid lines) together with their 95% confidence intervals (dashed lines). The results in the two Figures appear similar, since from Figure 5 it is seen that the factors T and σ have similar impact on the values of τ . Additionally, the confidence intervals are larger at lower probability values, which imply a larger variance on rare events.

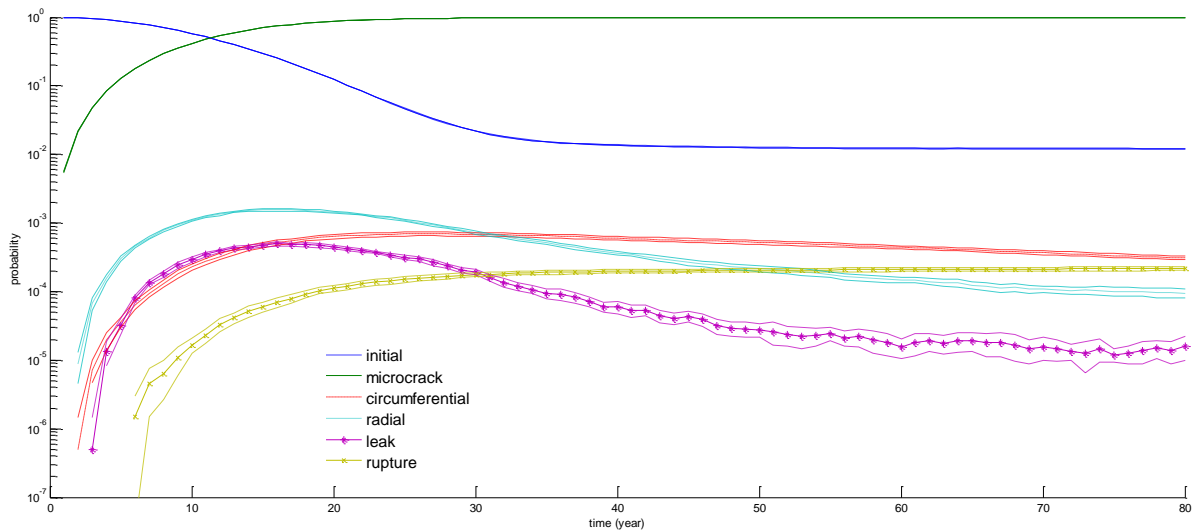

Figure 6. Simulation accommodating uncertainty in temperature

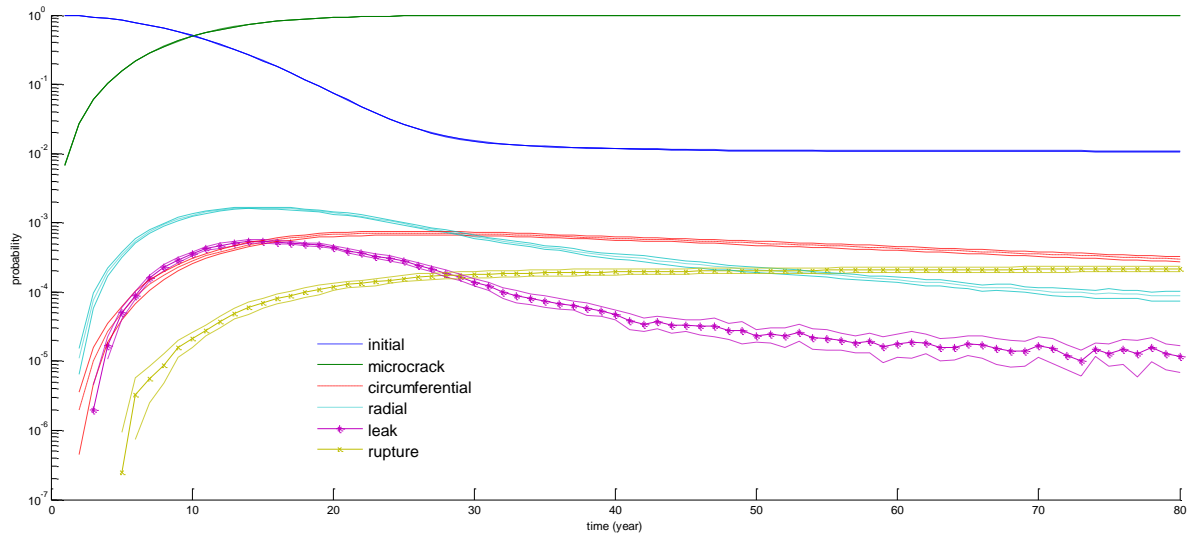

Figure 7. Simulation accommodating uncertainty in stress

Conclusion

The proposed modeling framework has been applied with success to describe the degradation process of a nuclear component. The transition rates are influenced by two independent environmental factors (e.g. temperature and stress), and the relationships are described by a set of physical functions. The comparison with analytical approximated results is satisfactory and the framework is indeed capable of explicitly accommodating the uncertainties in the environmental factors. Future research work is envisaged on the following aspects: 1) involve other types of influencing factors, e.g. failures of other equipment, bad maintenance quality, environment, etc; 2) use expert judgments to determine the relationships between these factors and the transition rates.

Acknowledgement

The authors would like to thank Mr. Mithlesh Kumar for the initial fruitful discussions during his stage work with the Chair on Systems Science and the Energetic Challenge, European Foundation for New Energy-Electricite' de France, at Ecole Centrale Paris, France.

References

ALY, O. F. Year. Preliminary Study for Extension and Improvement on Modeling of Primary Water Stress Corrosion Cracking at Control Rod Drive Mechanism Nozzles of Pressurized Water Reactors. *In: International Nuclear Atlantic Conference (INAC), 2009 Rio de Janeiro.*

- BARATA, J., GUEDES SOARES, C., MARSEGUERRA, M. & ZIO, E. 2002. Simulation modelling of repairable multi-component deteriorating systems for 'on condition' maintenance optimisation. *Reliability Engineering & System Safety*, 76, 255-264.
- CHANA, G. K. & ASGARPOOR, S. 2006. Optimum maintenance policy with Markov processes. *Electric Power Systems Research*, 76, 452-456.
- CHRYSSAPHINO, O., LIMNIOS, N. & MALEFAKI, S. 2011. Multi-State Reliability Systems Under Discrete Time Semi-Markovian Hypothesis. *IEEE Transactions on Reliability*, 60, 80-87.
- DUTUIT, Y., CHATELET, E., SIGNORET, J. P. & THOMAS, P. 1997. Dependability modeling and evaluation by using stochastic Petri nets: application to two test cases. *Reliability Engineering & System Safety*, 55, 117-124.
- ELSAIED, E. A. & LIAO, H. T. 2004. A geometric Brownian motion model for field degradation data. *International Journal of Materials and Product Technology* 20, 51-72.
- GEBRAEEL, N., ELWANY, A. & PAN, J. 2009. Residual Life Predictions in the Absence of Prior Degradation Knowledge. *IEEE Transactions on Reliability*, 58, 106-117.
- HOSSEINI, M. M., KERR, R. M. & RANDALL, R. B. 2000. An inspection model with minimal and major maintenance for a system with deterioration and Poisson failures. *IEEE Transactions on Reliability*, 49, 88-98.
- KIM, J. & MAKIS, V. 2009. Optimal maintenance policy for a multi-state deteriorating system with two types of failures under general repair. *Computers & Industrial Engineering*, 57, 298-303.
- KUO, W. & ZUO, M. J. 2003. *Optimal Reliability Modeling: Principles and Applications*, New York, John Wiley & Sons.
- LAWLESS, J. & CROWDER, M. 2004. Covariates and random effects in a gamma process model with application to degradation and failure. *Lifetime Data Analysis*, 10, 213-227.
- LI, Y. F., ZIO, E., LIN, Y. H. & KUMAR, M. 2012. Petri-Net Simulation Model of a Nuclear Component Degradation Process *PSAM 11 & ESREL 2012*. Helsinki, Finland.
- PETRI, C. A. 1966. Communication with automation. Griffis (NY): Rome Air Development Center.
- RUBINSTEIN, R. Y. & KROESE, D. P. 2009. *Simulation and the Monte Carlo Method*, Wiley.
- TRIVEDI, S. K. 2002. *Probability and statistics with reliability, queuing and computer science applications*, John Wiley and Sons.
- UNWIN, S. D., LOWRY, P. P., LAYTON, R. F., HEASLER, P. G. & TOLOCZKO, M. B. Year. Multi-state physics models of aging passive components in probabilistic risk assessment. In: *Proceedings of ANS PSA 2011 International Topical Meeting on Probabilistic Safety Assessment and Analysis*, 2011. 1-12.
- ZIO, E. & ZOIA, A. 2009. Parameter Identification in Degradation Modeling by Reversible-Jump Markov Chain Monte Carlo *IEEE Transactions on Reliability*, 58, 123-131.